

PRECEDENT

CATALOG 2026



4367-LL Melissa Left Arm Loveseat
4367-E1 Melissa Inside Corner
4367-SR Melissa Right Arm Sofa
975-110 Harvey Cocktail Table
975-111 Harvey End Table
975-112 Harvey Drink Table

Shown On Cover:

3539-C3 Carter Swivel Chair



180-KHR Forbes King Bed
3435-01 Niagara Small Ottoman
975-111 Harvey End Table



CONTENTS

<i>Sofas</i>	7
<i>Chaise & Bench</i>	39
<i>Accent Chairs</i>	41
<i>Swivel Chairs</i>	57
<i>Office Chairs</i>	71
<i>Dining Chairs</i>	73
<i>Ottomans</i>	79
<i>Beds</i>	87
<i>Sectionals</i>	97
<i>Studio P</i>	171
<i>Details</i>	213
<i>Index</i>	225

Did you know many of our best-selling frames are available in fabric *and* leather?

We have thousands of fabrics, leathers, and wood finishes to choose from! Keep an eye out for those icons underneath each product.



Available in Leather



Available in Fabric



ALL HANDMADE IN THE USA

PRECEDENT[®] MADE TO ORDER

Choose from hundreds of fabrics and leathers. Each piece is hand-upholstered to order by our skilled artisans here in North Carolina.

Explore our ever-expanding collections.

Notice the clean, neutral body fabric featured in our photos.

This clean look makes it easy to see differences in frame styles, as well as overlay fabric samples on photos.





3434-S1 Roan Sofa
 L4110-S1 Emma 3 Seat Standard Sofa
 3505-C1 Hudson Chair
 743-13 Stellan Round Cocktail Table
 MH25322-91 Ratean Spot Table
 743-22 Hollis End Table
 SER-001 Overlook Two Door Cabinet
 L3319-01 Simona Ottoman

SOFAS

**2145-S2
Ethan 3 Cushion Sofa**

85½w 35d 34H
 Inside: 74w 21d 15H
 Arm Height: 24 Seat Height:19
 Loose Pillow Back
 Standard With Two 20" Throw Pillows
 Finish Shown: Walnut



**2668-S2
Marshall Standard Sofa**

91w 40d 34H
 Inside: 72w 24d 17H
 Arm Height: 24 Seat Height:17
 Loose Pillow Back
 Standard With Two 20" Throw Pillows
 Finish Shown: Walnut



**2665-S3
Jake Long Sofa**

100w 40d 34H
 Inside: 81w 24d 17H
 Arm Height: 24 Seat Height:17
 Loose Pillow Back
 Standard With Two 20" Throw Pillows
 Finish Shown: Walnut



**2667-S1
Connor Short Sofa**

82w 40d 34H
 Inside: 63w 24d 17H
 Arm Height: 24 Seat Height:17
 Loose Pillow Back
 Standard With Two 20" Throw Pillows
 Finish Shown: Walnut



2668-S3 Marshall Long Sofa

**3015-S1
Oliver Sofa**

86W 38D 36H
 Inside: 78W 22D 18H
 Arm Height: 24 Seat Height:18
 Loose Pillow Back
 Standard With Two 20" Throw Pillows
 Finish Shown: Walnut



**3016-S2
Jennifer Long Sofa**

101W 42D 38H
 Inside: 93W 26D 20H
 Arm Height: 24 Seat Height:18
 Loose Pillow Back
 Standard With Four 20" Throw Pillows
 Finish Shown: Walnut



3015-S1 Oliver Sofa

**3149-S1
Braden Sofa**

83W 39D 34H
 Inside: 76W 22D 16H
 Arm Height: 24½ Seat Height:18
 Loose Pillow Back
 Standard With Two 20" Throw Pillows
 Finish Shown: Walnut



**3155-S1
Blake Sofa**

84½W 37D 33H
 Inside: 74½W 22D 15H
 Arm Height: 26 Seat Height:18
 Loose Pillow Back
 Standard With Two 20" Throw Pillows
 Finish Shown: Metal



**3182-S1
Bailey Sofa**

83W 35D 33½H
Inside: 75w 22D 16½H
Arm Height: 25½ Seat Height:17
Loose Pillow Back
Standard With Two Arm Bolsters
Finish Shown: Walnut



**3252-S1
Corbin Standard Sofa**

88w 35d 30½H
Inside: 77w 22D 12½H
Arm Height: 30½ Seat Height:18
Tight Back
Standard With Two 20" Throw Pillows
Finish Shown: Walnut



**3240-S1
Lindsay Sofa**

87½w 37½d 35H
Inside: 77w 22D 17H
Arm Height: 23½ Seat Height:18
Loose Pillow Back
Standard With Two 20" Throw Pillows
Finish Shown: Walnut



**3242-S1
Kenzie Sofa**

87½w 37½d 35H
Inside: 77w 22D 17H
Arm Height: 23½ Seat Height:18
Loose Pillow Back
Standard With Two 20" Throw Pillows
Finish Shown: Walnut



3240-S1 Lindsay Sofa
3333-C3 Claudia Swivel Chair
967-142 Puebla Etagere
968-221 Cambridge Oval Cocktail Table



**3276-S1
Michelle Sofa**

83W 36½D 36H
 Inside: 75W 22D 18H
 Arm Height: 32 Seat Height:18
 Loose Pillow Back
 Standard With Two 20" Throw Pillows
 Finish Shown: Walnut



**3286-S1
Michael Sofa**

83W 36½D 36H
 Inside: 75W 22D 18H
 Arm Height: 32 Seat Height:18
 Loose Pillow Back
 Standard With Two 20" Throw Pillows
 Finish Shown: Walnut



**3280-S1
Nicole Standard Sofa**

87W 38D 33H
 Inside: 74W 22D 15H
 Arm Height: 22 Seat Height:18
 Loose Pillow Back
 Standard With Two 20" Throw Pillows
 Finish Shown: Walnut



**3310-B1
Vera Short Sofa**

74½W 35½D 31H
 Inside: 51W 19D 12H
 Arm Height: 24 Seat Height:19
 Tight Back
 Standard With Two 18" Throw Pillows



**3282-S2
Hilton Long Sofa**

100W 42D 35H
 Inside: 87W 26D 17H
 Arm Height: 22 Seat Height:18
 Loose Pillow Back
 Standard With Four 20" Throw Pillows
 Finish Shown: Walnut



**3310-S1
Vera Standard Sofa**

92W 36½D 33½H
 Inside: 65W 22D 16½H
 Arm Height: 26 Seat Height:17
 Tight Back
 Standard With Two 20" Throw Pillows



**3320-S1
Zelda Sofa**

90½w 35½d 30H
 Inside: 78w 23d 13H
 Arm Height: 30 Seat Height:17
 Tight Back
 Standard With Two 20" Throw Pillows
 Finish Shown: Walnut



**3358-S1
Samuel Sofa**

91w 41d 39H
 Inside: 78w 22d 20H
 Arm Height: 25 Seat Height:19
 Loose Pillow Back
 Standard With Two 20" Throw Pillows
 Finish Shown: Walnut



**3364-S2
Arlington Sofa**

97w 39½d 39H
 Inside: 84w 22d 21H
 Arm Height: 25½ Seat Height:18
 Loose Pillow Back
 Standard With Two 20" Throw Pillows
 Finish Shown: Walnut



**3371-S1
Sarah Sofa**

86w 36d 32½H
 Inside: 75w 22d 15½H
 Arm Height: 23 Seat Height:17
 Loose Pillow Back
 Standard With Two 20" Throw Pillows
 Finish Shown: Walnut



**3376-S2
Angelina Sofa**

94½w 37d 35H
 Inside: 78w 22d 17H
 Arm Height: 27 Seat Height:18
 Loose Pillow Back
 Standard With Two 20" Throw Pillows
 Finish Shown: Walnut



**3382-S2
Raquel Sofa**

99w 36½d 34½H
 Inside: 81w 22d 17½H
 Arm Height: 26½ Seat Height: 17
 Loose Pillow Back
 Standard With Two 20" Throw Pillows
 Finish Shown: Walnut



3384-S1 Kristin Sofa
374-440 Ainsley Etagere



3384-S1 Kristin Sofa

89W 38½D 34½H
Inside: 79W 22D 16½H
Arm Height: 24 Seat Height: 18
Loose Pillow Back
Standard With Two 20" Throw Pillows
Finish Shown: Walnut



3388-S1 Renee Sofa

88W 36D 32½H
Inside: 77W 22D 14½H
Arm Height: 24½ Seat Height: 18
Tight Back
Standard With Two 20" Throw Pillows
Finish Shown: Walnut



3394-S1 Sydney Sofa

88½W 38D 31H
Inside: 75W 22D 14H
Arm Height: 24 Seat Height: 17
Tight Back
Standard With Two 20" Throw Pillows
Finish Shown: Walnut



**3400-S1
Miller Standard Sofa**

86W 38D 32H
Inside: 71W 22D 15H
Arm Height: 24 Seat Height: 17
Tight Back
Standard With Two 20" Throw Pillows
Finish Shown: Walnut



**3400-S2
Miller Long Sofa**

96W 38D 32H
Inside: 81W 22D 15H
Arm Height: 24 Seat Height: 17
Tight Back
Standard With Two 20" Throw Pillows
Finish Shown: Walnut



**3418-S2
Geneva Long Sofa**

100W 46D 29½H
Inside: 84W 26D 12H
Arm Height: 25½ Seat Height: 18
Loose Pillow Back
Finish Shown: Walnut



3418-S2 Geneva Long Sofa
L3469-02 Missy Caster Square Ottoman



3422-S1 Becca Sofa
L3321-01 Tina Ottoman
969-486 Castel Hex Accent Table



3422-S1 Becca Sofa

92w 37d 35h
Inside: 76w 23d 16h
Arm Height: 28 Seat Height: 19
Loose Pillow Back
Standard With Two 20" Throw Pillows
Finish Shown: Walnut



3424-S2 Dover Sofa

97w 41d 32h
Inside: 75w 22d 15h
Arm Height: 25 Seat Height: 17
Tight Back
Finish Shown: Walnut



3434-S1 Roan Sofa

87w 36d 33½h
Inside: 79½w 22d 13½h
Arm Height: 23 Seat Height: 20
Loose Pillow Back
Finish Shown: Walnut



3436-S2
Navie Curved Sofa

92W 45D 32H
Inside: 74W 23D 13H
Arm Height: 22 Seat Height: 19
Tight Back
Standard With Two 20" Throw Pillows
Finish Shown: Walnut



3438-S1
Banks Sofa

84W 41D 36H
Inside: 74½W 24D 18H
Arm Height: 25 Seat Height: 18
Loose Pillow Back
Standard With Two 20" Throw Pillows



3438-S2
Banks Long Sofa

96W 41D 36H
Inside: 86½W 24D 18H
Arm Height: 25 Seat Height: 18
Loose Pillow Back
Standard With Two 20" Throw Pillows



3436-S2 Navie Curved Sofa
3333-C3 Claudia Swivel Chair
L3319-01 Simona Leather Ottoman
MH25322-91 Ratean Spot Table



**3440-S1
Tracy Sofa**

92W 36D 32H
Inside: 71W 22D 14H
Arm Height: 25 Seat Height: 18
Tight Back
Standard With Two 20" Throw Pillows



**3448-S2
Moondance Sofa**

94W 38½D 31½H
Inside: 72W 23D 15½H
Arm Height: 26 Seat Height: 16
Tight Back



**3442-S1
Dalton Sofa**

88W 34D 34H
Inside: 76W 22D 17H
Arm Height: 23½ Seat Height: 17
Tight Back
Standard With Two 20" Throw Pillows
Finish Shown: Metal



**3450-S1
Martin Sofa**

88½W 38D 33H
Inside: 79½W 22D 15H
Arm Height: 24½ Seat Height: 18
Loose Pillow Back
Standard With Two 20" Throw Pillows
Finish Shown: Walnut



**3446-S2
Clapton Sofa**

97W 43D 35H
Inside: 70W 23D 16½H
Arm Height: 25 Seat Height: 18½
Loose Pillow Back



3448-S2 Clapton Sofa
969-486 Castel Hex Accent Table
SER-003D Mado Cocktail Table

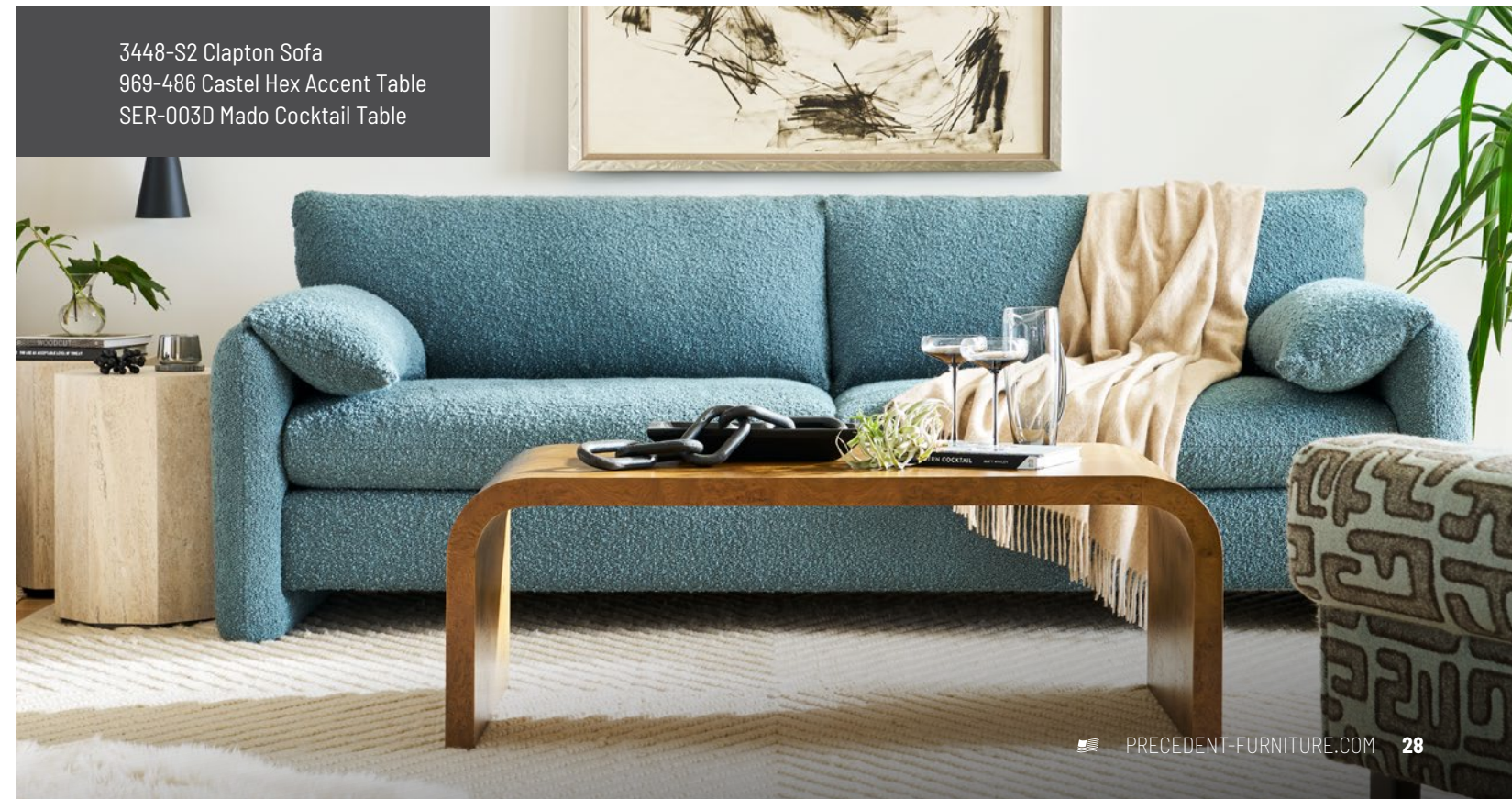

**3452-S2
Sabrina Long Sofa**

97W 43D 29H
Inside: 73W 24D 13H
Arm Height: 27 Seat Height: 16
Tight Back
Finish Shown: Walnut



**3454-S1
Kelly Sofa**

89W 37D 36H
Inside: 78½W 22D 17½H
Arm Height: 28½ Seat Height: 18½
Loose Pillow Back
Standard With Two 20" Throw Pillows
Finish Shown: Walnut



**3455-B1
Eve Bench**

64W 31D 30H
Inside: 56W 21D 12½H
Arm Height: 25 Seat Height: 17½
Tight Back



3454-S1 Kelly Sofa
L5108-01 Adeline Ottoman
603-24R Barton Right Side End Table



3458-S2 Arlo Long Sofa
SER-030D Mado Side Table



**3456-S1
Godiva Sofa**

93W 35½D 34H
Inside: 71½W 23D 15H
Arm Height: 21½ Seat Height: 18
Loose Pillow Back
Standard With Two 20" Throw Pillows



**3458-S1
Arlo Sofa**

84W 38D 32H
Inside: 66W 24D 13H
Arm Height: 24½ Seat Height: 16
Loose Pillow Back
Standard With Two 20" Throw Pillows



**3458-S2
Arlo Long Sofa**

89W 38D 32H
Inside: 74W 24D 13H
Arm Height: 24½ Seat Height: 16
Loose Pillow Back
Standard With Two 20" Throw Pillows



**3536-S1
Newman Short Sofa**

82W 40D 34H
Inside: 63W 24D 17H
Arm Height: 24 Seat Height 17
Loose Pillow Back
Standard With Two 20" Throw Pillows
Finish Shown: Walnut



**4110-B1
Emma 2 Seat Short Sofa**

71W 36D 32H
Inside: 59W 22½D 13H
Arm Height: 27 Seat Height:19
Tight Back
Standard With Two 20" Throw Pillows
Finish Shown: Walnut



**3567-S2
Larabee Standard Sofa**

91W 40D 34H
Inside: 72W 24D 17H
Arm Height: 24 Seat Height 17
Loose Pillow Back
Standard With Two 20" Throw Pillows
Finish Shown: Walnut



**4110-S1
Emma 3 Seat Standard Sofa**

88W 36D 32H
Inside: 76W 22½D 13H
Arm Height: 27 Seat Height:19
Tight Back
Standard With Two 20" Throw Pillows
Finish Shown: Walnut



**3568-S3
Clavin Long Sofa**

100W 40D 34H
Inside: 81W 24D 17H
Arm Height: 24 Seat Height 17
Loose Pillow Back
Standard With Two 20" Throw Pillows
Finish Shown: Walnut



4110-S1 Emma 3 Seat Sofa
368-840 Bunching Cocktail Table
967-165 Olivia Spot Table

**4125-S1
Keaton Mid Length Sofa**

79W 35D 31H
 Inside: 67W 21D 13H
 Arm Height: 26 Seat Height:18
 Tight Back
 Standard With Two 20" Throw Pillows
 Finish Shown: Walnut



**4168-B1
Marley Settee**

67W 30½D 32H
 Inside: 59W 21D 15H
 Arm Height: 23½ Seat Height:17
 Tight Back
 Finish Shown: Walnut



4168-B1 Marley Settee

**4365-S1
Astor Short Sofa**

82W 40D 34H
 Inside: 63W 24D 17H
 Arm Height: 24 Seat Height:17
 Loose Pillow Back
 Standard With Two 20" Throw Pillows
 Finish Shown: Walnut



**4367-S2
Melissa Standard Sofa**

91W 40D 34H
 Inside: 72W 24D 17H
 Arm Height: 24 Seat Height:17
 Loose Pillow Back
 Standard With Two 20" Throw Pillows
 Finish Shown: Walnut



**4368-S3
Whitman Long Sofa**

100W 40D 34H
 Inside: 81W 24D 17H
 Arm Height: 24 Seat Height:17
 Loose Pillow Back
 Standard With Two 20" Throw Pillows
 Finish Shown: Walnut



**4901-S2
Amy Long Sofa**

92½w 39d 37H
Inside: 84½w 22d 19H
Arm Height: 24½ Seat Height: 18
Loose Pillow Back
Standard With Two 20" Throw Pillows
Finish Shown: Walnut



**4903-S1
Kendrick Sofa**

90w 36½d 37½H
Inside: 78½w 22d 19½H
Arm Height: 24½ Seat Height: 18
Loose Pillow Back
Standard With Two 20" Throw Pillows
Finish Shown: Walnut



4903-LL Kendrick Left Arm Loveseat
4903-DR Kendrick Right Arm Corner Sofa



CHAISE & BENCH



3241-CL Sansa Left Arm Chaise
MH25322 Ratean Spot Table



3226-B1
Erin Bench

78W 26D 28½H
Inside: 69W 26D 10H
Arm Height: 28½ Seat Height: 18½
Standard With Two Arm Bolsters
Finish Shown: Walnut



3241-CL
Sansa Left Arm Chaise

29½W 78½D 29H
Inside: 26W 72D 11H
Arm Height: 21 Seat Height: 18
Standard With One Cylinder Pillow
Finish Shown: Walnut



3241-CR
Sansa Right Arm Chaise

29½W 78½D 29H
Inside: 26W 72D 11H
Arm Height: 21 Seat Height: 18
Standard With One Cylinder Pillow
Finish Shown: Walnut



3527-B1
Penrod Bench

78W 26D 28½H
Inside: 69W 26D 10H
Arm Height: 28½ Seat Height: 18½
Standard with Two Arm Bolsters
Finish Shown: Walnut



ACCENT CHAIRS



L3517-C1 Hopper Chair
969-485 Berto Bunching Cube



**2107-C1
Rona Chair**

33w 36d 32h
Inside: 24w 21d 12h
Arm Height: 24 Seat Height: 20
Tight Back
Finish Shown: Walnut



Also Available:

2107-01 Rona Ottoman

24w 20d 15½h



**2727-C1
Fisher Chair**

27½w 35d 32h
Inside: 20w 20d 14h
Arm Height: 25 Seat Height: 18
Loose Pillow Back
Finish Shown: Walnut



**2723-C1
Winston Chair**

32½w 33d 34h
Inside: 23w 23d 16½h
Arm Height: 23½ Seat Height: 17½
Tight Back
Finish Shown: Walnut



**2753-D2
Ella Arm Chair**

25w 27d 32½h
Inside: 20w 20d 13½h
Arm Height: 26½ Seat Height: 19
Tight Back
Finish Shown: Walnut





**3027-C1
Cary Chair**

32W 36D 35½H
Inside: 23W 22D 17½H
Arm Height: 23½ Seat Height:18
Tight Back
Finish Shown: Walnut



**3200-C1
Tristen Chair**

34W 38D 44½H
Inside: 22W 22D 26½H
Arm Height: 25½ Seat Height:18
Tight Back
Finish Shown: Walnut



Also Available:

3200-01 Tristen Ottoman

23½W 16½D 20½H



**3186-C1
Natalie Chair**

30W 36D 41½H
Inside: 19W 21D 23½H
Arm Height: 26 Seat Height:18
Tight Back
Standard With One Kidney Pillow
Finish Shown: Walnut



**3201-C1
Courtney Chair**

30W 31D 29H
Inside: 21W 23D 12H
Arm Height: 23 Seat Height:17
Tight Back
Finish Shown: Walnut



**3208-C1
Grant Chair**

28W 38D 41H
Inside: 21W 23D 24H
Arm Height: 18½ Seat Height:17
Tight Back
Finish Shown: Walnut



**3229-C1
Bella Chair**

32W 38D 42H
Inside: 23W 21D 24H
Arm Height: 18 Seat Height:18
Tight Back
Standard With One Kidney Pillow
Finish Shown: Walnut



**3209-C1
Erik Chair**

30W 35D 38H
Inside: 24W 21½D 21H
Arm Height: 25 Seat Height:17
Tight Back
Finish Shown: Walnut



Also Available:

3209-01 Erik Ottoman

27W 25D 16½H



**3233-C1
Aria Chair**

31W 32D 29½H
Inside: 24W 22D 12½H
Arm Height: 25½ Seat Height:17
Tight Back
Finish Shown: Walnut



L3405-C1 Margo Chair
 L3427-03 Eastwood Leather Swivel Ottoman
 3376-CL Angelina Left Arm Chaise
 3376-SR Angelina Right Arm Sofa



**3275-C1
 Kimberly Chair**

30W 32½D 29H
 Inside: 24W 22D 13H
 Arm Height: 24 Seat Height:16
 Tight Back
 Finish Shown: Walnut



**3279-C1
 Kayla Chair**

29W 33D 33½H
 Inside: 20W 22D 16½H
 Arm Height: 24 Seat Height:17
 Tight Back
 Finish Shown: Walnut



Also Available:

3279-01 Kayla Ottoman

28W 21D 16H



**3369-C1
 Christine Chair**

31W 32D 32½H
 Inside: 22W 21D 13½H
 Arm Height: 32 Seat Height:19
 Tight Back
 Finish Shown: Walnut



**3405-C1
 Margo Chair**

28W 32½D 31H
 Inside: 21W 21D 14½H
 Arm Height: 21 Seat Height:16½
 Tight Back
 Available In Solid White Oak With
 Black Metal Leg Only





**3411-C1
Wanda Chair**

29W 34D 34½H
Inside: 23W 21½D 16½H
Arm Height: 24½ Seat Height: 18
Tight Back
Finish Shown: Walnut



**3413-C1
Sierra Chair**

33W 38D 33H
Inside: 24W 20D 14H
Arm Height: 23½ Seat Height: 19
Loose Pillow Back
Finish Shown: Walnut



**3448-C1
Moondance Chair**

46W 38½D 31½H
Inside: 24W 24D 15½H
Arm Height: 26 Seat Height: 16
Tight Back



**3452-C1
Sabrina Chair**

37W 37D 30H
Inside: 20W 24D 14H
Arm Height: 27 Seat Height: 16
Tight Back
Finish Shown: Walnut



L3448-C1 Moondance Chair
MH32321 The Chairside Table



L3455-C1 Eve Chair
969-486 Castel Hex Accent Table



**3455-C1
Eve Chair**

31w 31d 30h
Inside: 22w 22d 12½h
Arm Height: 25 Seat Height: 17½
Tight Back



**3459-C1
Breck Chair**

31w 40d 35h
Inside: 23w 21d 16h
Arm Height: 24 Seat Height: 19
Loose Pillow Back
Finish Shown: Walnut



**3465-C1
Danza Chair**

30w 34½d 30h
Inside: 23½w 20d 12h
Arm Height: 20½ Seat Height: 18
Loose Pillow Back



**3505-C1
Hudson Chair**

28w 33d 34h
Inside: 25½w 22½d 15h
Arm Height: 23 Seat Height: 19
Tight Back
Finish Shown: Walnut



Also Available:

3505-01 Hudson Ottoman

24w 20d 14h



**3515-C1
Farley Chair**

37w 34d 32H
Inside: 23 1/2w 21d 15H
Arm Height: 22 Seat Height: 17
Loose Pillow Back



**3517-C1
Hopper Chair**

29w 37d 40H
Inside: 23w 19d 23H
Arm Height: 26 Seat Height: 17
Tight Back
Finish Shown: Walnut



**3519-C1
Hollie Chair**

29w 29d 32H
Inside: 25w 21d 13H
Arm Height: 25 Seat Height: 19
Tight Back
Finish Shown: Walnut



**3531-C1
Tuttle Chair**

30w 30d 30H
Inside: 21w 22d 12H
Arm Height: 24 1/2 Seat Height: 18
Tight Back



3519-C1 Hollie Chair
MH25322 Ratean Spot Table



3533-C1 Margarete Chair
 3454-S1 Kelly Sofa
 603-24L Barton Left Side End Table



3533-C1 Margarete Chair

31W 34½D 32½H
 Inside: 22W 22D 15H
 Arm Height: 27 Seat Height: 17½
 Tight Back
 Finish Shown: Walnut



3537-C1 Emerie Chair

31W 32D 31H
 Inside: 23½W 21½D 13H
 Arm Height: 26 Seat Height: 18
 Tight Back



4113-C1 Jasper Chair

38W 38D 36H
 Inside: 28W 22D 18H
 Arm Height: 20 Seat Height: 18
 Tight Back
 Finish Shown: Walnut



4168-C1 Marley Chair

32W 30½D 32H
 Inside: 23W 21D 15H
 Arm Height: 23½ Seat Height: 17
 Tight Back
 Finish Shown: Walnut





**4179-C1
Grayson Chair**

31w 32d 32½h
Inside: 25w 21d 15½h
Arm Height: 24½ Seat Height: 17
Tight Back
Available In Solid Walnut Only



**4186-C1
Hunter Chair**

31w 31d 33½h
Inside: 22w 21d 16h
Arm Height: 25½ Seat Height: 17½
Tight Back
Finish Shown: Walnut



3310-S1 Vera Sofa
L4179-C1 Grayson Leather Chair

3509-C3 Elton Memory Swivel Chair
 3438-S1 Banks Sofa
 MH33310 Birly Coffee Table
 MH22321 Luna Side Table



SWIVEL CHAIRS



**2557-C3
Dalton Swivel Chair**

32W 39D 33½H
 Inside: 22W 21D 15½H
 Arm Height: 25½ Seat Height: 18
 Loose Pillow Back



**3119-C3
Gordon Swivel Chair**

33½W 36D 31H
 Inside: 23½W 21D 14H
 Arm Height: 22½ Seat Height: 17
 Loose Pillow Back



**3168-C3
Phillip Swivel Chair**

31W 35D 35H
 Inside: 22W 22D 17H
 Arm Height: 23½ Seat Height: 18
 Loose Pillow Back



**3169-C3
Ramsey Swivel Chair**

31W 34D 33H
 Inside: 22W 22D 15H
 Arm Height: 23½ Seat Height: 18
 Loose Pillow Back





3192-C3
Sherman Swivel Chair

31W 34D 31½H
Inside: 22W 23D 14H
Arm Height: 26 Seat Height: 17½
Tight Back



3257-C3
Tara Swivel Chair

31½W 36D 28½H
Inside: 21W 23D 11½H
Arm Height: 19½ Seat Height: 17
Tight Back



3333-C3
Claudia Swivel Chair

31W 30D 29½H
Inside: 21W 22D 11H
Arm Height: 23 Seat Height: 18½
Tight Back
Finish Shown: Walnut



3341-C3
Enzo Swivel Chair

33½W 36½D 32½H
Inside: 24W 23D 15½H
Arm Height: 24 Seat Height: 17
Tight Back



3273-C3
Kathleen Swivel Chair

34W 38D 34H
Inside: 24W 22D 16H
Arm Height: 24 Seat Height: 18
Loose Pillow Back



3313-C3
Luna Swivel Chair

33W 33D 32H
Inside: 22W 23½D 15H
Arm Height: 24 Seat Height: 17
Tight Back



3363-C3
Lovato Swivel Chair

30½W 33D 31H
Inside: 22W 22D 14H
Arm Height: 29 Seat Height: 17
Tight Back



3365-C3
Charlotte Swivel Chair

32½W 35D 33½H
Inside: 22W 22D 16½H
Arm Height: 25½ Seat Height: 17
Tight Back



3410-LC Corkscrew Swivel Chair Left
3410-RC Corkscrew Swivel Chair Right



**3403-C3
Suzette Swivel Chair**

34½w 33d 33h
Inside: 22w 23d 17h
Arm Height: 23 Seat Height: 16
Tight Back



**L3410-LC Corkscrew
Leather Swivel Chair Left**

34w 35d 30h
Inside: 22w 21d 11h
Arm Height: 30 Seat Height: 19
Tight Back



**3415-C3
Rae Swivel Chair**

28w 33d 32½h
Inside: 21w 23d 16½h
Arm Height: 24 Seat Height: 16
Tight Back
Finish Shown: Walnut



**L3410-RC Corkscrew
Leather Swivel Chair Right**

34w 35d 30h
Inside: 22w 21d 11h
Arm Height: 30 Seat Height: 19
Tight Back



SWIVEL CHAIRS



3448-C3
Moondance Swivel Chair

46W 38½D 31½H
Inside: 24W 24D 15½H
Arm Height: 26 Seat Height: 16
Tight Back



3452-C3
Sabrina Swivel Chair

37W 37D 30H
Inside: 20W 24D 14H
Arm Height: 27 Seat Height: 16
Tight Back



3461-C3
Wright Swivel Chair

33½W 35½D 32H
Inside: 24W 22D 15H
Arm Height: 23½ Seat Height: 17
Tight Back
Finish Shown: Walnut



3471-C3
Joshua Swivel Chair

32W 35D 30H
Inside: 26W 21D 10H
Arm Height: 30 Seat Height: 20
Loose Pillow Back
Finish Shown: Walnut



3461-C3 Wright Swivel Chair





**3473-C3
Exeter Swivel Chair**

41½W 36½D 30½H
Inside: 23W 23D 13½H
Arm Height: 24½ Seat Height: 17
Tight Back



**3479-C3
Halsey Swivel Chair**

28W 32D 31H
Inside: 21W 22D 13H
Arm Height: 26 Seat Height: 18
Tight Back



**3501-C3
Ridge Swivel Chair**

36W 36½D 30½H
Inside: 28W 23D 13½H
Arm Height: 23½ Seat Height: 17
Tight Back



**3503-C3
Edward Swivel Chair**

42W 42D 27H
Inside: 35W 32D 10H
Arm Height: 23 Seat Height: 17
Loose Pillow Back
Standard With Three 20" Throw Pillows





**3509-C3
Elton Memory Return
Swivel Chair**

31w 31d 29½h
Inside: 22w 22d 12½h
Arm Height: 20 Seat Height: 17
Tight Back



**3529-C3
Wilder Swivel Chair**

31w 33½d 32h
Inside: 23½w 24½d 14h
Arm Height: 24 Seat Height: 18
Tight Back
Finish Shown: Walnut



**3535-C3
Cline Swivel Chair**

34½w 34d 29½h
Inside: 22w 22½d 12½h
Arm Height: 23½ Seat Height: 17
Tight Back



**3539-C3
Carter Swivel Chair**

29w 35d 31½h
Inside: 21w 22d 13½h
Arm Height: 27½ Seat Height: 18
Tight Back
Finish Shown: Walnut



5133-C3 Andre Memory Return Swivel Chair
VMA-301 Wren Cabinet



**4113-C3
Jasper Swivel Chair**

38w 38d 36h
Inside: 28w 22d 18h
Arm Height: 20 Seat Height: 18
Tight Back
Available In Chrome Finish Only



Also Available:

4113-01 Jasper Ottoman

25w 20d 17h



**5133-C3
Andre Memory Return
Swivel Chair**

30½w 28½d 30h
Inside: 19w 21d 11h
Arm Height: 28 Seat Height: 19
Tight Back



**9015-C3
Maya Swivel Chair**

34w 35d 32h
Inside: 22w 21d 14h
Arm Height: 23 Seat Height: 18
Semi-Attached Back



**9306-C3
Riley Swivel Chair**

34½w 36d 33½h
Inside: 20w 20d 14½h
Arm Height: 27 Seat Height: 19
Tight Back



OFFICE CHAIRS



3419-OC Layla Office Chair



3417-OC Dorsey Office Chair

20½w 26d 37h
Inside: 19w 17d 20h
Seat Height: 17
Tight Back
Available In Chrome Finish Only



3419-OC Layla Office Chair

25½w 29d 34½h
Inside: 19w 19d 17½h
Arm Height: 22 Seat Height: 17
Tight Back
Available In Chrome Finish Only



3423-OC Elon Office Chair

27w 27½d 36½h
Inside: 18w 19d 19½h
Arm Height: 21½ Seat Height: 17
Tight Back
Available In Chrome Finish Only



Heights for the office chairs are noted with the mechanism placed in the lowest position. The mechanism has the capability to increase the height by up to 3 inches.

DINING CHAIRS



2753-D2 Ella Arm Chair
975-121 Malcolm Dining Table
975-120 Malcolm Console Table



**2594-D1
Luc Dining Side Chair**

23W 28½D 39½H
Inside: 18W 19D 20H
Seat Height: 19½
Tight Back
Shown With Optional Nail Trim
Finish Shown: Walnut



**2598-D1
Reid Dining Side Chair**

23W 29D 40H
Inside: 23W 18½D 20½H
Seat Height: 19½
Tight Back
Shown With Optional Nail Trim
Finish Shown: Walnut



**2913-D1
Cora Dining Side Chair**

24W 28D 39½H
Inside: 23W 19D 20½H
Seat Height: 19
Tight Back
Shown With Optional Nail Trim
Finish Shown: Walnut



**3130-D1
Nora Dining Side Chair**

23W 28½D 39½H
Inside: 18W 19D 20H
Seat Height: 19½
Tight Back
Shown With Optional Nail Trim
Finish Shown: Walnut



**2598-D2
Reid Dining Arm Chair**

25W 29D 40H
Inside: 20W 18½D 20½H
Arm Height: 25 Seat Height: 19½
Tight Back
Finish Shown: Walnut



**2753-D2
Ella Arm Chair**

25W 27D 32½H
Inside: 20W 20D 13½H
Arm Height: 26½ Seat Height: 19
Tight Back
Shown With Optional Nail Trim
Finish Shown: Walnut



**3373-D1
Hopkins Dining Side Chair**

22W 25½D 35H
Inside: 21W 19D 16H
Seat Height: 19
Tight Back
Finish Shown: Walnut



**3373-D2
Hopkins Dining Arm Chair**

24½W 25½D 35H
Inside: 17W 19D 16H
Arm Height: 23½ Seat Height: 19
Tight Back
Finish Shown: Walnut





3377-D2
Ariana Dining Arm Chair

24w 26½d 31h
Inside: 19w 19d 12h
Arm Height: 27½ Seat Height: 19
Tight Back
Finish Shown: Walnut



3433-D2
Carraway Dining Arm Chair

25½w 25d 36h
Inside: 18w 18d 17h
Arm Height: 24½ Seat Height: 19
Tight Back
Finish Shown: Walnut



3427-D2
Rainier Dining Arm Chair

26w 27d 31½h
Inside: 17w 18d 12½h
Arm Height: 26 Seat Height: 19
Tight Back



3427-D2 Rainier Dining Arm Chair
975-113 Harvey Game Table

OTTOMANS



3280-SL Nicole Left Arm Sofa
 3280-CR Nicole Right Arm Chaise
 3435-04 Niagara King Ottoman



160-QOS Peyton Queen Storage Ottoman

64w 21d 18½h
 Seat Height: 18½
 Finish Shown: Walnut



Also Available in Twin, Queen, King, and Cal King



L160-TOS Peyton Leather Twin Storage Ottoman

43½w 21d 18½h
 Seat Height: 18½
 Finish Shown: Walnut



Also Available in Twin, Queen, King, and Cal King



2090-02 Elliot Caster Ottoman

17½w 17½d 18½h
 Seat Height: 18½



2233-K1 Mia Caster Keg Ottoman

22w 22d 16h
 Seat Height: 16
 Single Button Tufted Top



2233-K2 Mia Caster Keg Ottoman

22w 22d 18½h
 Seat Height: 18½
 Single Button Tufted Top



2233-K3 Mia Caster Keg Ottoman

22w 22d 21½h
 Seat Height: 21½
 Single Button Tufted Top





2338-02
Leah Caster Round Ottoman

38w 38d 17h
Seat Height: 17
Single Button Tufted Top



2541-01
Gavyn Ottoman

25w 25d 18½h
Seat Height: 18½
Finish Shown: Walnut



3321-04
Tina Square Ottoman

37w 37d 14h
Seat Height: 14



3321-05
Tina Small Cube Ottoman

23w 23d 17h
Seat Height: 17



3134-01
Drew Button Tufted Ottoman

53½w 23d 16½h
Seat Height: 16½
Finish Shown: Walnut



L3319-01
Simona Leather Ottoman

27w 27d 19h
Seat Height: 19
Available As Shown Only



3383-03
Rami Swivel Ottoman

26w 26d 17½h
Seat Height: 17½
Finish Shown: Walnut



3425-01
Lorie Ottoman

53½w 23d 16½h
Seat Height: 16½
Finish Shown: Walnut



3321-01
Tina Round Ottoman

18w 18d 18½h
Seat Height: 18½



3321-03
Tina Round Ottoman

37w 37d 14h
Seat Height: 14



L3427-03
Eastwood Leather Swivel Ottoman

26w 26d 17½h
Seat Height: 17½
Available In Brindle Hair On Hide Leather Only



3439-02
Louise Caster Round Ottoman

38w 38d 17h
Seat Height: 17





L3435-01
Niagara Leather Small Ottoman

25w 20d 19h
Seat Height: 19



3435-01
Niagara Small Ottoman

25w 20d 19h
Seat Height: 19



3435-03
Niagara Queen Ottoman

49w 20d 19h
Seat Height: 19



3435-04
Niagara King Ottoman

61w 20d 19h
Seat Height: 19



3469-02
Missy Caster Ottoman

19w 19d 19h
Seat Height: 19
Standard With Casters



L3481-02
Melissa Leather Ottoman

19w 19d 19h
Seat Height: 19
Standard With Casters
Available In Brindle Hair On Hide Leather Only

1KS-AJNU Nocturne King Storage Bed
3435-01 Niagara Small Ottoman



3418-S3 Geneva Extra Long Sofa
3465-C1 Danza Chair
L3481-02 Melissa Caster Ottoman
603-24R Barton Right Side End Table



**3505-01
Hudson Ottoman**

24w 20d 14h



**4164-01
Dayton Ottoman**

53½w 21d 18h
Seat Height: 18
Finish Shown: Walnut



BEDS

3279- C1 Kayla Chair
3279-01 Kayla Ottoman
176-QHR Nebo Queen Headboard & Rails





**130-QHR
Mackenzie Queen Headboard & Rails**

67½w 89D 58H
Finish Shown: Walnut



**158-QHR
Caleb Queen Headboard & Rails**

66w 93D 48½H
Platform Bed Is Engineered To Accept A Mattress Only, No Box Spring Needed.
Finish Shown: Walnut



161-QHS Beckett Queen Headboard, Rails & Storage Drawer
 3465-C1 Danza Chair
 3400-S2 Miller Long Sofa
 VMA-075 Sienna End Table
 VMA-416 Daisy Round Accent Table
 MH22321 Luna Side Table



161-QHR
Beckett Queen Headboard & Rails

66w 87d 59H
 Platform Bed Is Engineered To Accept A Mattress Only, No Box Spring Needed.
 Finish Shown: Walnut



161-QHS
**Beckett Queen Headboard,
 Rails & Storage Drawer**

66w 87d 59H
 Platform Bed Is Engineered To Accept A Mattress Only, No Box Spring Needed.
 Finish Shown: Walnut





176-QHR
Nebo Queen Headboard & Rails

76W 102D 45H
Platform Bed Is Engineered To Accept A Mattress Only, No Box Spring Needed.
Finish Shown: Walnut



178-THR
Slater Twin Headboard & Rails

45½W 82D 65H
Platform Bed Is Engineered To Accept A Mattress Only, No Box Spring Needed.
Finish Shown: Walnut



178-KHR
Slater King Headboard & Rails

82½W 86D 65H
Platform Bed Is Engineered to Accept A Mattress Only, No Box Spring Needed.
Finish Shown: Walnut



178-QHR
Slater Queen Headboard & Rails

66½W 86D 65H
Platform Bed Is Engineered to Accept A Mattress Only, No Box Spring Needed.
Finish Shown: Walnut





180-QHR
Forbes Queen Headboard & Rails

77½W 98D 44H
Platform Bed Is Engineered to Accept A Mattress Only. No Box Spring Needed.
Finish Shown: Walnut



259-QHR
Roxanne Queen Headboard & Rails

66W 88½D 41H
Platform Bed Is Engineered To Accept A Mattress Only, No Box Spring Needed.
Available In Metal Finish Only



259-QHR Roxanne Queen Headboard & Rails
347-440 Ainsley Etagere

SECTIONALS

3405-C1 Margo Chair
2666-CSL Kylie Curved Left Arm Sofa
2666-CSO Kylie Curved Armless Sofa
2666-CSR Kylie Curved Right Arm Sofa
MH25322-91 Rateau Spot Table



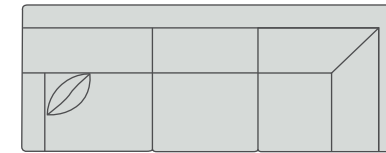

2145-DL
Ethan Left Arm Corner Sofa
92W 37D 34H
Inside: 73W 21D 15H
Standard With One 20" Throw Pillow

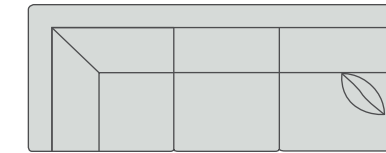

2145-DR
Ethan Right Arm Corner Sofa
92W 37D 34H
Inside: 73W 21D 15H
Standard With One 20" Throw Pillow

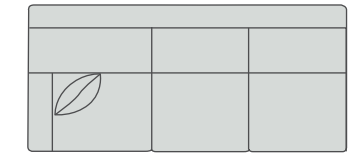

2145-SL
Ethan Left Arm Sofa
2145-QL
Ethan Left Arm Queen Sleeper
80W 37D 34H
Inside: 70W 21D 15H
Standard With One 20" Throw Pillow

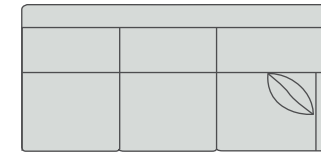

2145-SR
Ethan Right Arm Sofa
2145-QR
Ethan Right Arm Queen Sleeper
80W 37D 34H
Inside: 70W 21D 15H
Standard With One 20" Throw Pillow

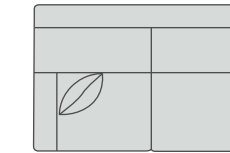

2145-LL
Ethan Left Arm Loveseat
55W 37D 34H
Inside: 50W 21D 15H
Standard With One 20" Throw Pillow

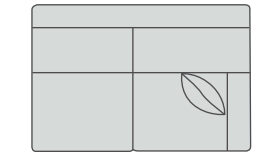

2145-LR
Ethan Right Arm Loveseat
55W 37D 34H
Inside: 50W 21D 15H
Standard With One 20" Throw Pillow

2145-SL
Ethan Left Arm Sofa

80W 37D 34H
Inside: 70W 21D 15H
Arm Height: 24 Seat Height: 19
Loose Pillow Back
Standard With One 20" Throw Pillow
Finish Shown: Walnut

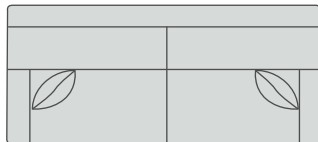

2145-S1
Ethan 2 Cushion Sofa
2145-Q1
Ethan Queen Sleeper
79W 35D 34H
Inside: 67½W 21D 15H
Standard With Two 20" Throw Pillows

2145-CU
Ethan Wedge

73W 42D 34H
Inside: 52W 21D 15H
Seat Height: 19
Wall Space: 50"
Loose Pillow Back
Standard With One 20" Throw Pillow
Finish Shown: Walnut

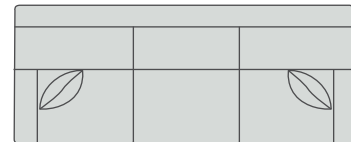

2145-S2
Ethan 3 Cushion Sofa
85½W 35D 34H
Inside: 74W 21D 15H
Standard With Two 20" Throw Pillows

2145-SR
Ethan Right Arm Sofa

80W 37D 34H
Inside: 70W 21D 15H
Arm Height: 24 Seat Height: 19
Loose Pillow Back
Standard With One 20" Throw Pillow
Finish Shown: Walnut

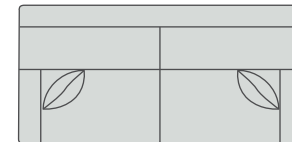

2145-B1
Ethan Short Sofa
2145-R1
Ethan Full Sleeper
71W 35D 34H
Inside: 59½W 21D 15H
Standard With Two 20" Throw Pillows

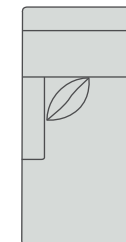

2145-CL
Ethan Left Arm Chaise
30W 60D 34H
Inside: 25W 44D 15H
Standard With One 20" Throw Pillow

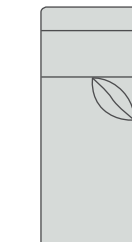

2145-CR
Ethan Right Arm Chaise
30W 60D 34H
Inside: 25W 44D 15H
Standard With One 20" Throw Pillow

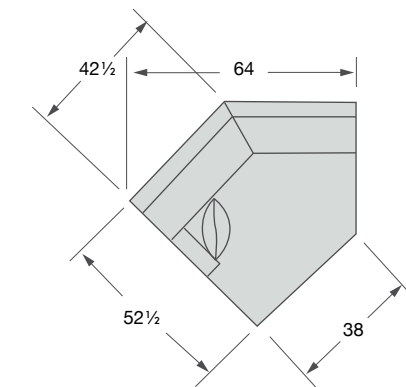

2145-WL
Ethan Left Arm Wedge
75W 52½D 34H
Inside: 52W 21D 15H
Standard With One 20" Throw Pillow

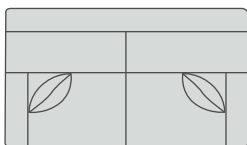

2145-L1
Ethan Loveseat
61W 35D 34H
Inside: 49½W 21D 15H
Standard With Two 20" Throw Pillows

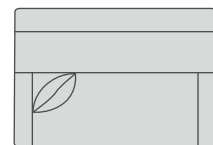

2145-T1
Ethan Chair Twin Sleeper
51W 35D 34H
Inside: 39½W 21D 15H
Standard With One 20" Throw Pillow

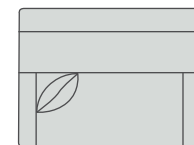

2145-C1
Ethan Chair & Half
46W 35D 34H
Inside: 34½W 21D 15H
Standard With One 20" Throw Pillow



2145-L0
Ethan Armless Loveseat
50W 37D 34H
Inside: 50W 21D 15H

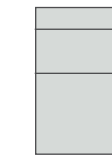

2145-A1
Ethan Armless Chair
25W 37D 34H
Inside: 25W 21D 15H

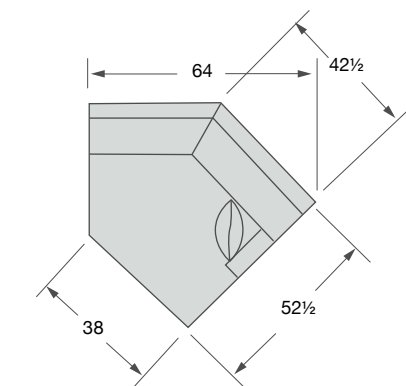

2145-WR
Ethan Right Arm Wedge
75W 52½D 34H
Inside: 52W 21D 15H
Standard With One 20" Throw Pillow

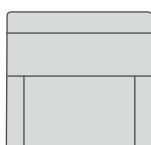

2145-C2
Ethan Chair
37W 35D 34H
Inside: 25½W 21D 15H



2145-O1
Ethan Ottoman & Half
38W 26D 19H



2145-O3
Ethan Ottoman
34W 26D 19H



2145-OS
Ethan Storage Caster Ottoman
37W 25D 17H

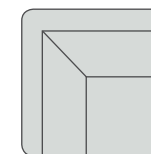

2145-E1
Ethan Inside Corner
37W 37D 34H
Inside: 21W 21D 15H

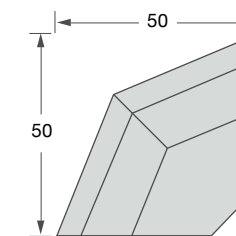

2145-CU
Ethan Wedge
73W 42D 34H
Inside: 52W 21D 15H

2145-S1 Ethan 2 Cushion Sofa
2723-C1 Winston Chair



**L2145-S1
Ethan Leather
2 Cushion Sofa**

79w 35d 34h
Inside: 67½w 21d 15h
Arm Height: 24 Seat Height: 19
Loose Pillow Back
Finish Shown: Walnut

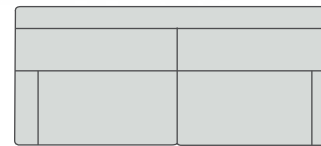

**L2145-S1
Ethan Leather 2 Cushion Sofa
L2145-Q1
Ethan Leather Queen Sleeper**
79w 35d 34h
Inside: 67½w 21d 15h

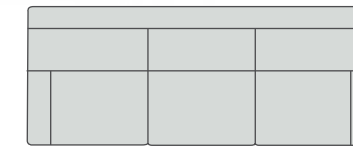

**L2145-S2
Ethan Leather 3 Cushion Sofa**
85½w 35d 34h
Inside: 74w 21d 15h

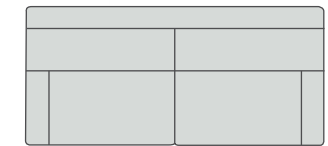

**L2145-B1
Ethan Leather Short Sofa
L2145-R1
Ethan Leather Full Sleeper**
71w 35d 34h
Inside: 59½w 21d 15h



**L2145-C1
Ethan Leather Chair & Half**
46w 35d 34h
Inside: 34½w 21d 15h

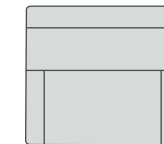

**L2145-C2
Ethan Leather Chair**
37w 35d 34h
Inside: 25½w 21d 15h



**L2145-01
Ethan Leather Ottoman & Half**
38w 26d 19h



**L2145-03
Ethan Leather Ottoman**
34w 26d 19h

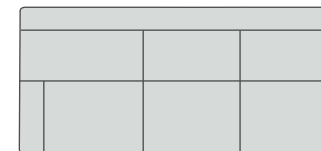

**L2145-SL
Ethan Leather Left Arm Sofa
L2145-QL
Ethan Leather Left Arm Queen Sleeper**
80w 37d 34h
Inside: 70w 21d 15h

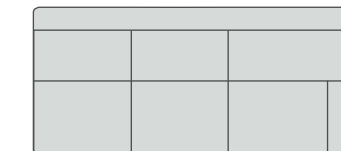

**L2145-SR
Ethan Leather Right Arm Sofa
L2145-QR
Ethan Leather Right Arm Queen Sleeper**
80w 37d 34h
Inside: 70w 21d 15h

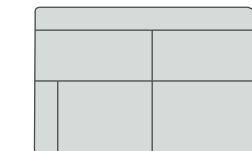

**L2145-LL
Ethan Leather Left Arm Loveseat**
55w 37d 34h
Inside: 50w 21d 15h

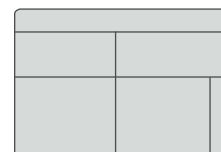

**L2145-LR
Ethan Leather Right Arm Loveseat**
55w 37d 34h
Inside: 50w 21d 15h

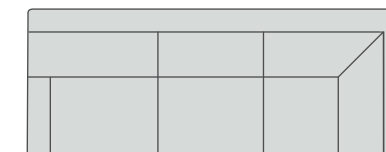

**L2145-DL
Ethan Leather Left Arm Corner Sofa**
92w 37d 34h
Inside: 73w 21d 15h

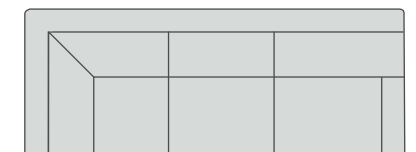

**L2145-DR
Ethan Leather Right Arm Corner Sofa**
92w 37d 34h
Inside: 73w 21d 15h

L2145 Ethan Leather Sectional Series Components 1/4" = 1" Scale



2665-CA
Jake Armless Chaise

32W 67½D 34H
Inside: 32w 51½D 17H
Seat Height:17
Loose Pillow Back
Finish Shown: Walnut

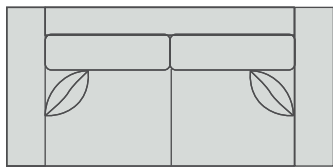

2665-S1
Jake Short Sofa
82W 40D 34H
Inside: 63W 24D 17H
Standard With Two 20" Throw Pillows

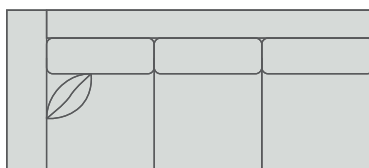

2665-SL
Jake Left Arm Sofa
92W 40D 34H
Inside: 82½W 24D 17H
Standard With One 20" Throw Pillow

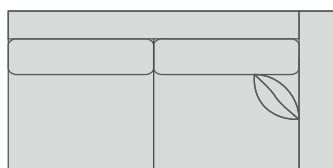

2665-JR
Jake Right Arm Wide Loveseat
83W 40D 34H
Inside: 73½W 24D 17H
Standard With One 20" Throw Pillow
Married To 2665-KL

2665-L0
Jake Armless Standard Loveseat

66W 40D 34H
Inside: 66W 24D 17H
Seat Height:17
Loose Pillow Back
Finish Shown: Walnut

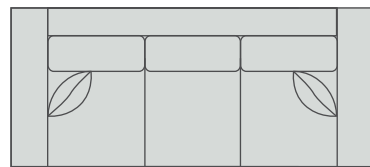

2665-S2
Jake Standard Sofa
91W 40D 34H
Inside: 72W 24D 17H
Standard With Two 20" Throw Pillows

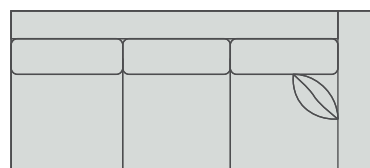

2665-SR
Jake Right Arm Sofa
92W 40D 34H
Inside: 82½W 24D 17H
Standard With One 20" Throw Pillow

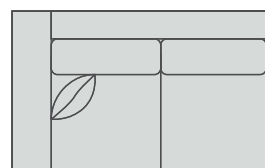

2665-LL
Jake Left Arm Loveseat
64W 40D 34H
Inside: 54½W 24D 17H
Standard With One 20" Throw Pillow

2665-E1
Jake Inside Corner

40W 40D 34H
Inside: 24W 24D 17H
Seat Height:17
Loose Pillow Back
Finish Shown: Walnut

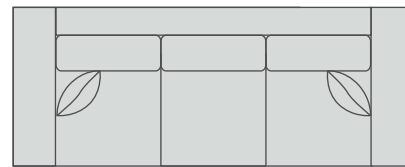

2665-S3
Jake Long Sofa
100W 40D 34H
Inside: 81W 24D 17H
Standard With Two 20" Throw Pillows

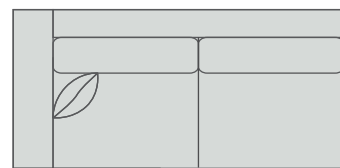

2665-JL
Jake Left Arm Wide Loveseat
83W 40D 34H
Inside: 73½W 24D 17H
Standard With One 20" Throw Pillow
Married To 2665-KR

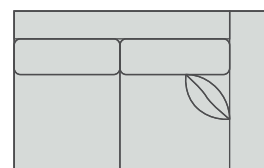

2665-LR
Jake Right Arm Loveseat
64W 40D 34H
Inside: 54½W 24D 17H
Standard With One 20" Throw Pillow

2665-SR
Jake Right Arm Sofa

92W 40D 34H
Inside: 82½W 24D 17H
Arm Height: 24 Seat Height:17
Loose Pillow Back
Standard With One 20" Throw Pillow
Finish Shown: Walnut

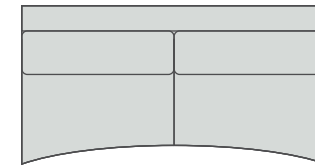

2665-S0
Jake Shaped Armless Sofa
76½W 40D 34H
Inside: 76½W 24D 17H



2665-A1
Jake Armless Chair
28W 40D 34H
Inside: 28W 24D 17H

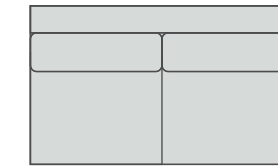

2665-L0
Jake Armless Standard Loveseat
66W 40D 34H
Inside: 66W 24D 17H

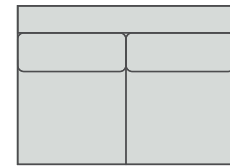

2665-B0
Jake Armless Short Loveseat
56W 40D 34H
Inside: 56W 24D 17H

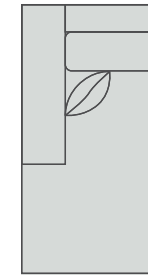

2665-CL
Jake Left Arm Chaise
36W 67½D 34H
Inside: 26½W 51½D 17H
Standard With One 20" Throw Pillow

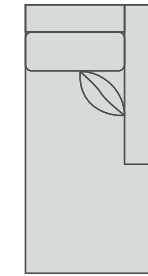

2665-CR
Jake Right Arm Chaise
36W 67½D 34H
Inside: 26½W 51½D 17H
Standard With One 20" Throw Pillow

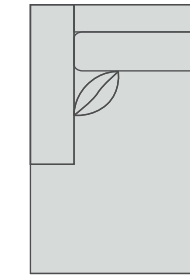

2665-KL
Jake Left Arm Chaise
45W 67½D 34H
Inside: 35½W 51½D 17H
Standard With One 20" Throw Pillow
Married To 2665-JR

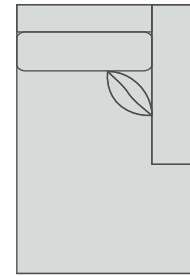

2665-KR
Jake Right Arm Chaise
45W 67½D 34H
Inside: 35½W 51½D 17H
Standard With One 20" Throw Pillow
Married To 2665-JL



2665-CA
Jake Armless Chaise
32W 67½D 34H
Inside: 32W 51½D 17H

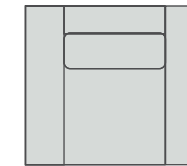

2665-C1
Jake Chair
45W 40D 34H
Inside: 26W 24D 17H

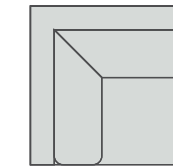

2665-E1
Jake Inside Corner
40W 40D 34H
Inside: 24W 24D 17H

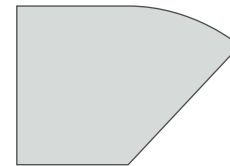

2665-BL
Jake Left Bumper Ottoman
56W 40D 17H



2665-L04
Jake Left Shaped Ottoman
35W 50D 17H

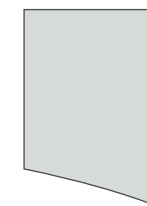

2665-R04
Jake Right Shaped Ottoman
35W 50D 17H



2665-01
Jake Ottoman
40W 28D 17H



2665-03
Jake Ottoman & Half
50W 40D 17H

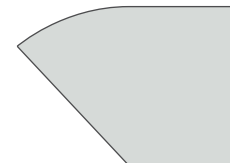

2665-BR
Jake Right Bumper Ottoman
56W 40D 17H

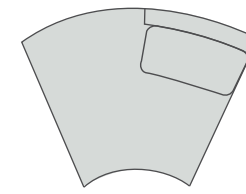

2666-CCL
Kylie Curved Chaise Left
62W 45D 34H
Inside: 52W 24D 17H

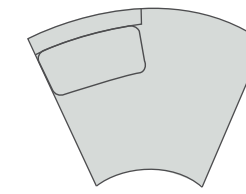

2666-CCR
Kylie Curved Chaise Right
62W 45D 34H
Inside: 52W 24D 17H

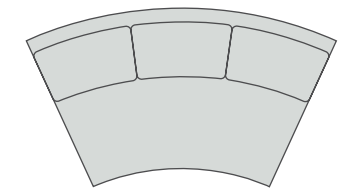

2666-CS0
Kylie Curved Armless Sofa
78W 45D 34H
Inside: 46W 24D 17H

2666-CSL
Kylie Curved Left Arm Sofa

85W 45D 34H
Inside: 75½W 24D 17H
Seat Height:17
Loose Pillow Back
Standard With One 20" Throw Pillow
Finish Shown: Walnut

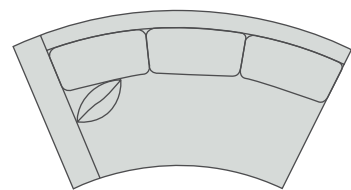

2666-CSL
Kylie Curved Left Arm Sofa

85W 45D 34H
Inside: 75½W 24D 17H
Standard With One 20" Throw Pillow

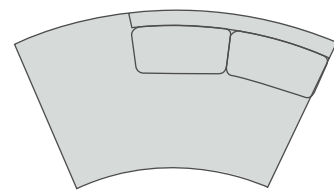

2666-CBL
Kylie Curved Left Bumper

81W 45D 34H
Inside: 65W 24D 17H

2666-CBR
Kylie Curved Right Bumper

81W 45D 34H
Inside: 65W 24D 17H
Seat Height:17
Loose Pillow Back
Finish Shown: Walnut

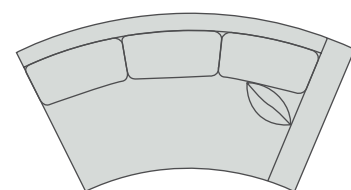

2666-CSR
Kylie Curved Right Arm Sofa

85W 45D 34H
Inside: 75½W 24D 17H
Standard With One 20" Throw Pillow

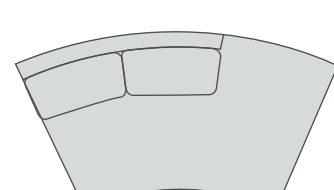

2666-CBR
Kylie Curved Right Bumper

81W 45D 34H
Inside: 65W 24D 17H

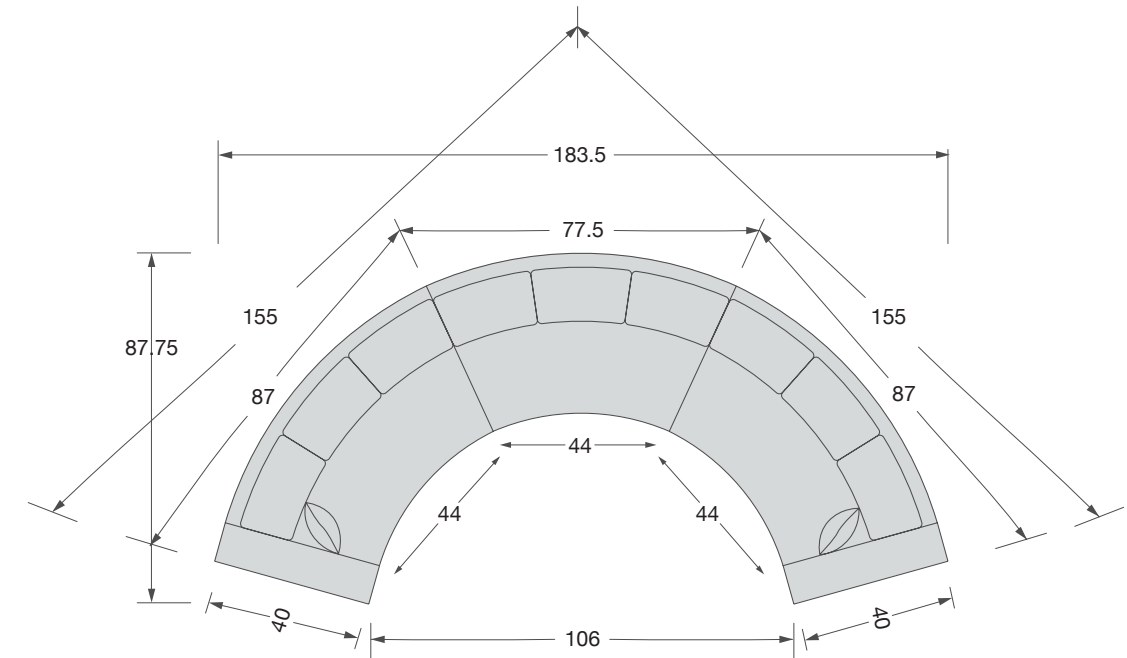

2666-CSL Kylie Curved Left Arm Sofa
2666-CS0 Kylie Curved Armless Sofa
2666-CSR Kylie Curved Right Arm Sofa

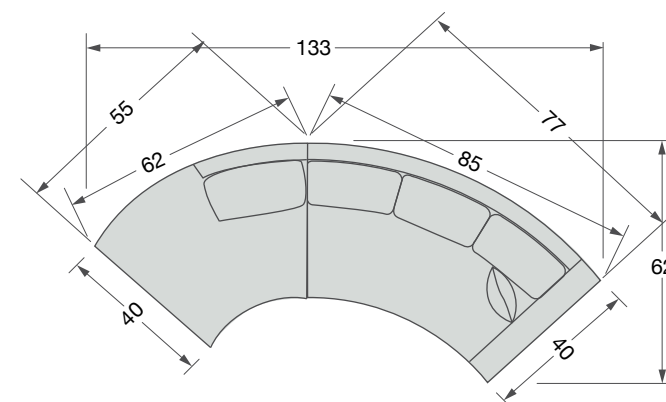

2666-CCL Kylie Curved Chaise Left
2666-CSR Kylie Curved Right Arm Sofa

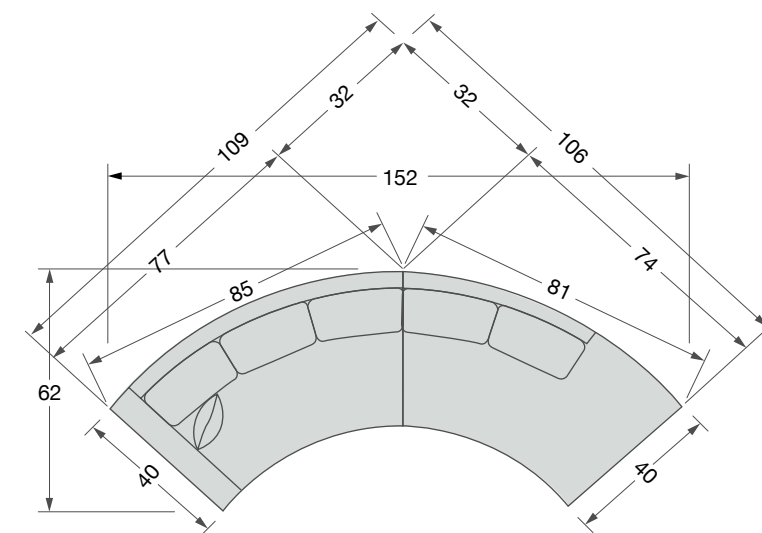

2666-CSL Kylie Curved Left Arm Sofa
2666-CBR Kylie Curved Right Bumper

2667-LL Connor Left Arm Loveseat
2667-E1 Connor Inside Corner
2667-SR Connor Right Arm Sofa





2667-SL
Connor Left Arm Sofa

92W 40D 34H
Inside: 82½W 24D 17H
Arm Height: 24 Seat Height: 17
Loose Pillow Back
Standard With One 20" Throw Pillow
Finish Shown: Walnut

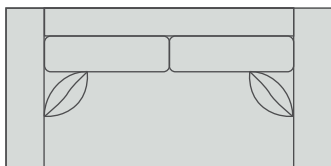

2667-S1
Connor Short Sofa
82W 40D 34H
Inside: 63W 24D 17H
Standard With Two 20" Throw Pillows



2667-SL
Connor Left Arm Sofa
92W 40D 34H
Inside: 82½W 24D 17H
Standard With One 20" Throw Pillow

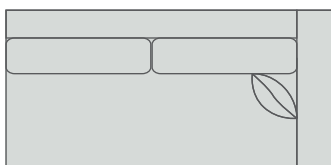

2667-JR
Connor Right Arm Wide Loveseat
83W 40D 34H
Inside: 73½W 24D 17H
Standard With One 20" Throw Pillow
Married To 2667-KL

2667-E1
Connor Inside Corner

40W 40D 34H
Inside: 24W 24D
Seat Height: 17
Loose Pillow Back
Finish Shown: Walnut

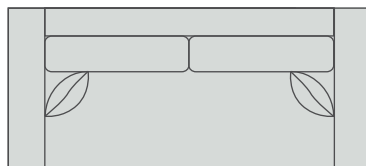

2667-S2
Connor Standard Sofa
91W 40D 34H
Inside: 74W 24D 17H
Standard With Two 20" Throw Pillows

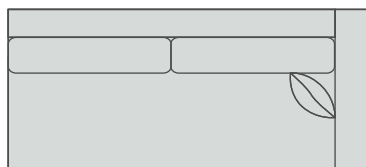

2667-SR
Connor Right Arm Sofa
92W 40W 34H
Inside: 82½W 24D 17H
Standard With One 20" Throw Pillow

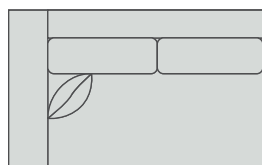

2667-LL
Connor Left Arm Loveseat
64W 40D 34H
Inside: 54½W 24D 17H
Standard With One 20" Throw Pillow

2667-LR
Connor Right Arm Loveseat

64W 40D 34H
Inside: 54½W 24D 17H
Arm Height: 24 Seat Height: 17
Loose Pillow Back
Standard With One 20" Throw Pillow
Finish Shown: Walnut

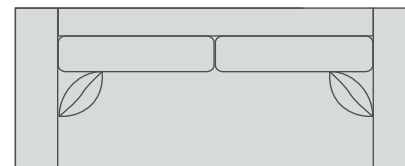

2667-S3
Connor Long Sofa
100W 40D 34H
Inside: 83W 24D 17H
Standard With Two 20" Throw Pillows

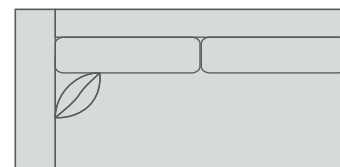

2667-JL
Connor Left Arm Wide Loveseat
83W 40D 34H
Inside: 73½W 24D 17H
Standard With One 20" Throw Pillow
Married To 2667-KR

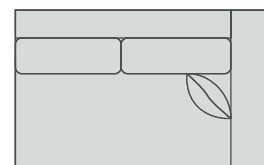

2667-LR
Connor Right Arm Loveseat
64W 40D 34H
Inside: 54½W 24D 17H
Standard With One 20" Throw Pillow

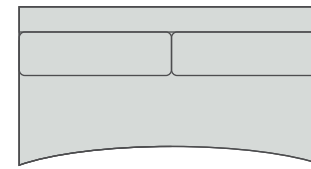

2667-S0
Connor Shaped Armless Sofa
76½W 40D 34H
Inside: 76½W 24D 17H

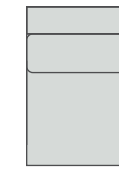

2667-A1
Connor Armless Chair
28W 40D 34H
Inside: 28W 24D 17H

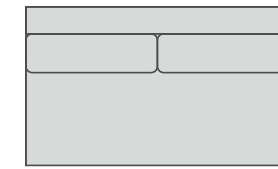

2667-L0
Connor Armless Standard Loveseat
66W 40D 34H
Inside: 66W 24D 17H

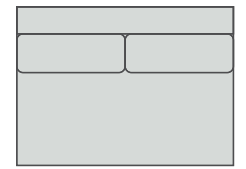

2667-B0
Connor Armless Short Loveseat
56W 40D 34H
Inside: 56W 24D 17H

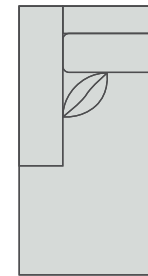

2667-CL
Connor Left Arm Chaise
36W 67½D 34H
Inside: 26½W 51½D 17H
Standard With One 20" Throw Pillow

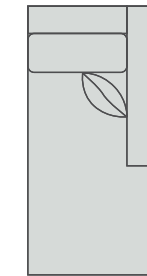

2667-CR
Connor Right Arm Chaise
36W 67½D 34H
Inside: 26½W 51½D 17H
Standard With One 20" Throw Pillow

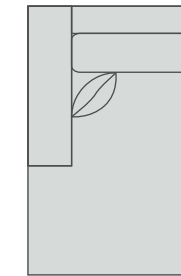

2667-KL
Connor Left Arm Chaise
45W 67½D 34H
Inside: 35½W 51½D 17H
Standard With One 20" Throw Pillow
Married To 2667-JR

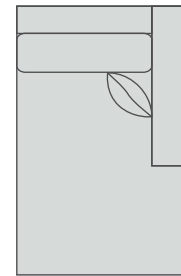

2667-KR
Connor Right Arm Chaise
45W 67½D 34H
Inside: 35½W 51½D 17H
Standard With One 20" Throw Pillow
Married To 2667-JL



2667-CA
Connor Armless Chaise
32W 67½D 34H
Inside: 32W 51½D 17H

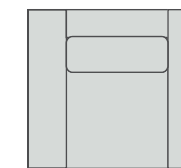

2667-C1
Connor Chair
45W 40D 34H
Inside: 26W 24D 17H

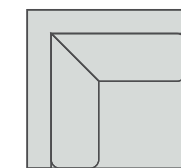

2667-E1
Connor Inside Corner
40W 40D 34H
Inside: 24W 24D 17H

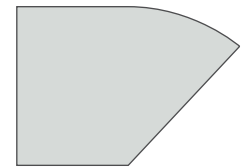

2667-BL
Connor Left Bumper Ottoman
56W 40D 17H

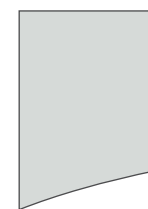

2667-L04
Connor Left Shaped Ottoman
35W 50D 17H

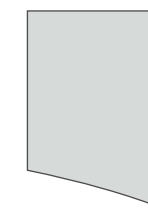

2667-R04
Connor Right Shaped Ottoman
35W 50D 17H



2667-O1
Connor Ottoman
40W 28D 17H



2667-O3
Connor Ottoman & Half
50W 40D 17H

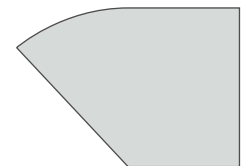

2667-BR
Connor Right Bumper Ottoman
56W 40D 17H



2668-SL
Marshall Left Arm Sofa

92W 40D 34H
Inside: 82½W 24D 17H
Arm Height: 24 Seat Height:17
Loose Pillow Back
Standard With One 20" Throw Pillow
Finish Shown: Walnut

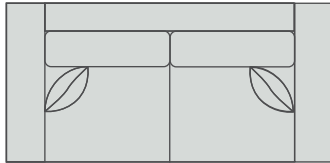

2668-S1
Marshall Short Sofa
82W 40D 34H
Inside: 63W 24D 17H
Standard With Two 20" Throw Pillows



2668-SL
Marshall Left Arm Sofa
92W 40D 34H
Inside: 82½W 24D 17H
Standard With One 20" Throw Pillow



2668-JR
Marshall Right Arm Wide Loveseat
83W 40D 34H
Inside: 73½W 24D 17H
Standard With One 20" Throw Pillow
Married To 2668-KL

2668-E1
Marshall Inside Corner

40W 40D 34H
Inside: 24W 24D 17H
Seat Height:17
Loose Pillow Back
Finish Shown: Walnut

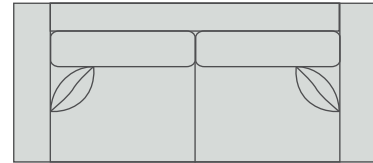

2668-S2
Marshall Standard Sofa
91W 40D 34H
Inside: 72W 24D 17H
Standard With Two 20" Throw Pillows



2668-SR
Marshall Right Arm Sofa
92W 40D 34H
Inside: 82½W 24D 17H
Standard With One 20" Throw Pillow

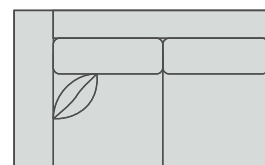

2668-LL
Marshall Left Arm Loveseat
64W 40D 34H
Inside: 54½W 24D 17H
Standard With One 20" Throw Pillow

2668-SR
Marshall Right Arm Loveseat

92W 40D 34H
Inside: 82½W 24D 17H
Arm Height: 24 Seat Height:17
Loose Pillow Back
Standard With One 20" Throw Pillow
Finish Shown: Walnut

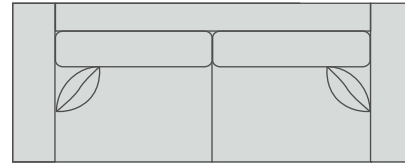

2668-S3
Marshall Long Sofa
100W 40D 34H
Inside: 81W 24D 17H
Standard With Two 20" Throw Pillows

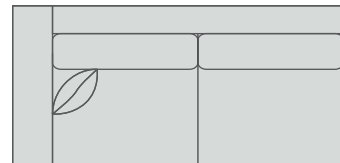

2668-JL
Marshall Left Arm Wide Loveseat
83W 40D 34H
Inside: 73½W 24D 17H
Standard With One 20" Throw Pillow
Married To 2668-KR

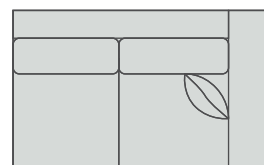

2668-LR
Marshall Right Arm Loveseat
64W 40D 34H
Inside: 54½W 24D 17H
Standard With One 20" Throw Pillow

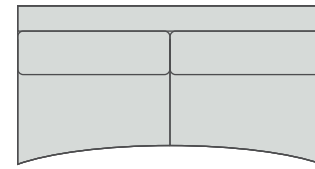

2668-S0
Marshall Shaped Armless Sofa
76½W 40D 34H
Inside: 76½W 24D 17H



2668-A1
Marshall Armless Chair
28W 40D 34H
Inside: 28W 24D 17H

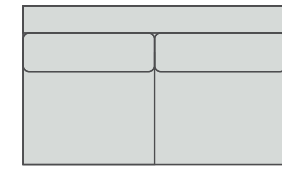

2668-L0
Marshall Armless Standard Loveseat
66W 40D 34H
Inside: 66W 24D 17H

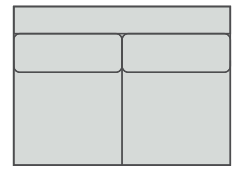

2668-B0
Marshall Armless Short Loveseat
56W 40D 34H
Inside: 56W 24D 17H

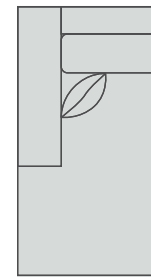

2668-CL
Marshall Left Arm Chaise
36W 67½D 34H
Inside: 26½W 51½D 17H
Standard With One 20" Throw Pillow

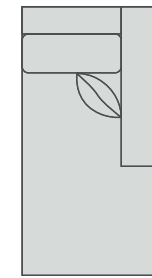

2668-CR
Marshall Right Arm Chaise
36W 67½D 34H
Inside: 26½W 51½D 17H
Standard With One 20" Throw Pillow

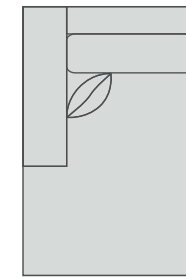

2668-KL
Marshall Left Arm Chaise
45W 67½D 34H
Inside: 35½W 51½D 17H
Standard With One 20" Throw Pillow
Married To 2668-JR

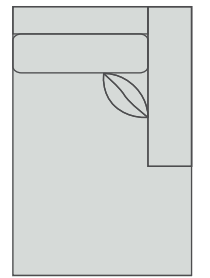

2668-KR
Marshall Right Arm Chaise
45W 67½D 34H
Inside: 35½W 51½D 17H
Standard With One 20" Throw Pillow
Married To 2668-JL



2668-CA
Marshall Armless Chaise
32W 67½D 34H
Inside: 32W 51½D 17H

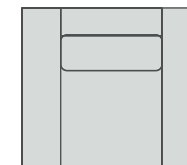

2668-C1
Marshall Chair
45W 40D 34H
Inside: 26W 24D 17H

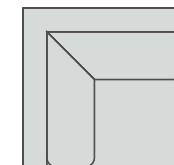

2668-E1
Marshall Inside Corner
40W 40D 34H
Inside: 24W 24D 17H

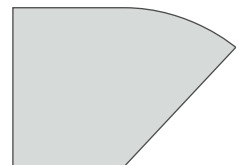

2668-BL
Marshall Left Bumper Ottoman
56W 40D 17H



2668-L04
Marshall Left Shaped Ottoman
35W 50D 17H

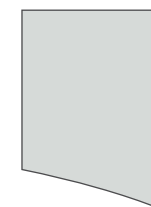

2668-R04
Marshall Right Shaped Ottoman
35W 50D 17H



2668-O1
Marshall Ottoman
40W 28D 17H



2668-O3
Marshall Ottoman & Half
50W 40D 17H

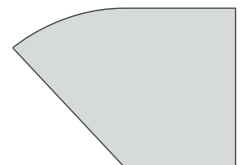

2668-BR
Marshall Right Bumper Ottoman
56W 40D 17H



3015-SL
Oliver Left Arm Sofa

82W 38D 36H
Inside: 78W 22D 18H
Arm Height: 24 Seat Height:18
Loose Pillow Back
Standard With One 20" Throw Pillow
Finish Shown: Walnut



3015-CR
Oliver Right Arm Chaise

44W 66½D 36H
Inside: 39W 52D 18H
Arm Height: 24 Seat Height:18
Loose Pillow Back
Standard With One 20" Throw Pillow
Finish Shown: Walnut



3015-S1
Oliver Sofa

86W 38D 36H
Inside: 78W 22D 18H
Standard With Two 20" Throw Pillows



3015-S2
Oliver Long Sofa

101W 38D 36H
Inside: 93W 22D 18H
Standard With Two 20" Throw Pillows

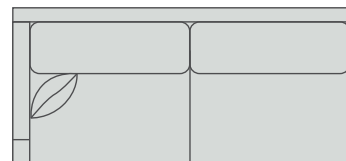

3015-SL
Oliver Left Arm Sofa

82W 38D 36H
Inside: 78W 22D 18H
Standard With One 20" Throw Pillow

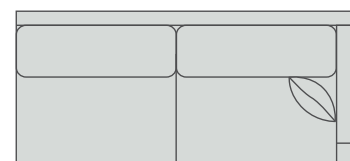

3015-SR
Oliver Right Arm Sofa

82W 38D 36H
Inside: 78W 22D 18H
Standard With One 20" Throw Pillow

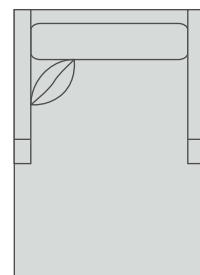

3015-CC
Oliver 2 Arm Chaise

47W 60D 33H
Inside: 33W 52D 18H
Standard With One 20" Throw Pillow

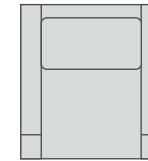

3015-C1
Oliver Chair

35W 38D 36H
Inside: 24½W 22D 18H

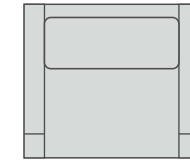

3015-CH
Oliver Chair & Half

43½W 38D 36H
Inside: 33W 22D 18H

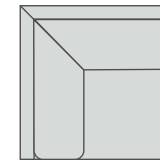

3015-E1
Oliver Inside Corner Chair

38W 38D 36H
Inside: 22W 22D 18H

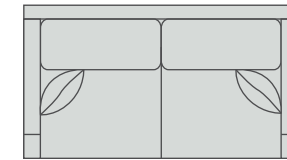

3015-L1
Oliver Loveseat

68W 38D 36H
Inside: 60W 22D 18H
Standard With Two 20" Throw Pillows

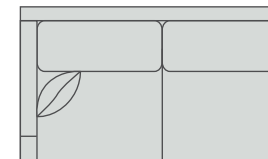

3015-LL
Oliver Left Arm Loveseat

66W 38D 36H
Inside: 60W 22D 18H
Standard With One 20" Throw Pillow

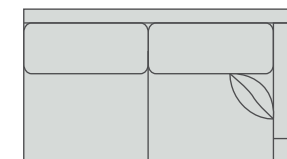

3015-LR
Oliver Right Arm Loveseat

66W 38D 36H
Inside: 60W 22D 18H
Standard With One 20" Throw Pillow

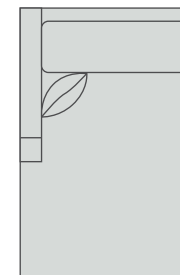

3015-CL
Oliver Left Arm Chaise

44W 66½D 36H
Inside: 39W 52D 18H
Standard With One 20" Throw Pillow

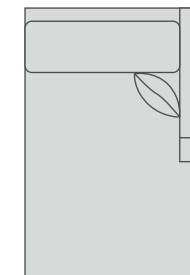

3015-CR
Oliver Right Arm Chaise

44W 66½D 36H
Inside: 39W 52D 18H
Standard With One 20" Throw Pillow



3015-O1
Oliver Ottoman

26W 23D 17H



3015-OH
Oliver Ottoman & Half

38W 26D 17H



**3182-LL
Bailey Left Arm Loveseat**

54w 35d 33½h
 Inside: 50w 22d 16½h
 Arm Height: 25½ Seat Height: 17
 Loose Pillow Back
 Standard With One Arm Bolster Pillow
 Finish Shown: Walnut

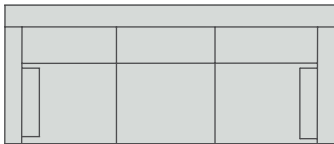

**3182-DR
Bailey Right Arm Corner Sofa**

87½w 35d 33½h
 Inside: 74w 22d 16½h
 Arm Height: 25½ Seat Height: 17
 Loose Pillow Back
 Standard With One Arm Bolster Pillow
 Finish Shown: Walnut

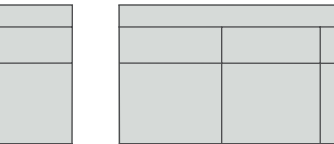

3182-S1 Bailey Sofa

83w 35d 33½h
 Inside: 75w 22d 16½h
 Standard With Two Arm Bolster Pillows

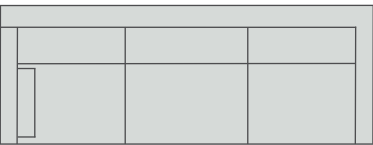

3182-SL Bailey Left Arm Sofa

78w 35d 33½h
 Inside: 74w 22d 16½h
 Standard With One Arm Bolster Pillow

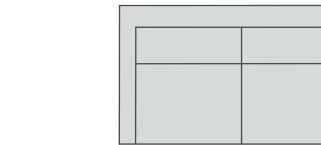

3182-SR Bailey Right Arm Sofa

78w 35d 33½h
 Inside: 74w 22d 16½h
 Standard With One Arm Bolster Pillow

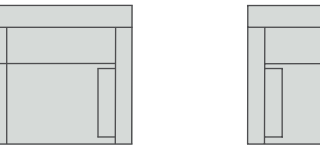

3182-C1 Bailey Chair

34½w 35d 33½h
 Inside: 26½w 22d 16½h



3182-DL Bailey Left Arm Corner Sofa

87½w 35d 33½h
 Inside: 74w 22d 16½h
 Standard With One Arm Bolster Pillow

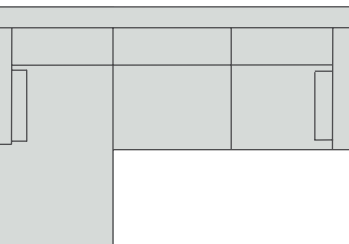

3182-DR Bailey Right Arm Corner Sofa

87½w 35d 33½h
 Inside: 74w 22d 16½h
 Standard With One Arm Bolster Pillow

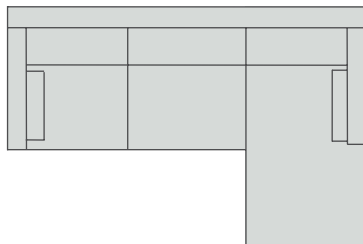

3182-LL Bailey Left Arm Loveseat

54w 35d 33½h
 Inside: 50w 22d 16½h
 Standard With One Arm Bolster Pillow

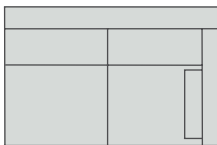

3182-SC Bailey Sofa Chaise

89½w 61d 33½h
 Inside: 81½w 22d 16½h
 Illustrated With Base Extension
 & Seat Cushion On Left
 Standard With Two Arm Bolster Pillows

3182-SC Bailey Sofa Chaise

89½w 61d 33½h
 Inside: 81½w 22d 16½h
 Illustrated With Base Extension
 & Seat Cushion On Right
 Standard With Two Arm Bolster Pillows

3182-LR Bailey Right Arm Loveseat

54w 35d 33½h
 Inside: 50w 22d 16½h
 Standard With One Arm Bolster Pillow

3182-SC Bailey Sofa Chaise



3280-SL Nicole Left Arm Sofa
3280-CR Nicole Right Arm Chaise
3461-C3 Wright Swivel Chair
3435-04 Niagara King Bench





3280-CL
Nicole Left Arm Chaise

47w 65d 33H
Inside: 39½w 52d 15H
Arm Height: 22 Seat Height:18
Loose Pillow Back
Standard With One 20" Throw Pillow
Finish Shown: Walnut



3280-SR
Nicole Right Arm Sofa

83½w 38d 33H
Inside: 73½w 22d 15H
Arm Height: 22 Seat Height:18
Loose Pillow Back
Standard With One 20" Throw Pillow
Finish Shown: Walnut



3282-SL
Hilton Left Arm Sofa

83w 42d 35H
Inside: 73½w 26d 17H
Arm Height: 22 Seat Height:18
Loose Pillow Back
Standard With Two 20" Throw Pillows
Finish Shown: Walnut



3282-CR
Hilton Right Arm Chaise

47w 65d 35H
Inside: 39½w 52d 17H
Arm Height: 22 Seat Height:18
Loose Pillow Back
Standard With Two 20" Throw Pillows
Finish Shown: Walnut

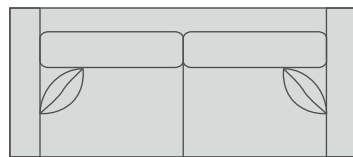

3280-S1
Nicole Standard Sofa
87w 38d 33H
Inside: 74w 22d 15H
Standard With Two 20" Throw Pillows

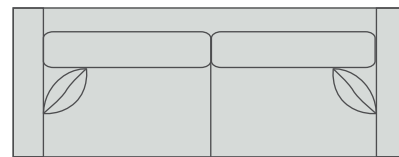

3280-S2
Nicole Long Sofa
100w 38d 33H
Inside: 87w 22d 15H
Standard With Two 20" Throw Pillows

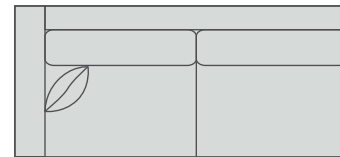

3280-SL
Nicole Left Arm Sofa
83½w 38d 33H
Inside: 73½w 22d 15H
Standard With One 20" Throw Pillow

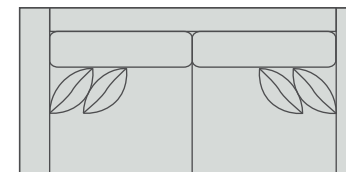

3282-S1
Hilton Standard Sofa
87w 42d 35H
Inside: 74w 26d 17H
Standard With Four 20" Throw Pillows

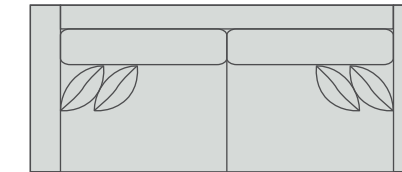

3282-S2
Hilton Long Sofa
100w 42d 35H
Inside: 87w 26d 17H
Standard With Four 20" Throw Pillows

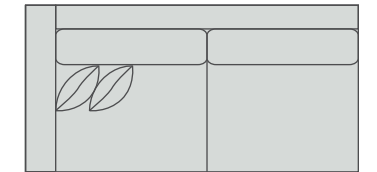

3282-SL
Hilton Left Arm Sofa
83w 42d 35H
Inside: 73½w 26d 17H
Standard With Two 20" Throw Pillows



3280-SR
Nicole Right Arm Sofa
83½w 38d 33H
Inside: 73½w 22d 15H
Standard With One 20" Throw Pillow

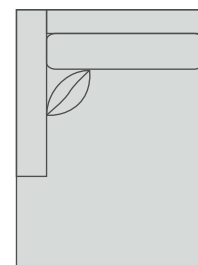

3280-CR
Nicole Right Arm Chaise
47w 65d 33H
Inside: 39½w 52d 15H
Standard With One 20" Throw Pillow

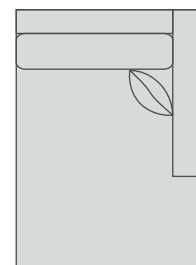

3280-CL
Nicole Left Arm Chaise
47w 65d 33H
Inside: 39½w 52d 15H
Standard With One 20" Throw Pillow

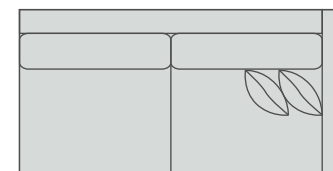

3282-SR
Hilton Right Arm Sofa
83w 42d 35H
Inside: 73½w 26d 17H
Standard With Two 20" Throw Pillows

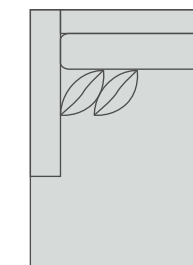

3282-CL
Hilton Left Arm Chaise
47w 65d 35H
Inside: 39½w 52d 17H
Standard With Two 20" Throw Pillows

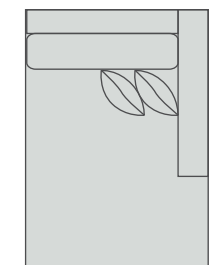

3282-CR
Hilton Right Arm Chaise
47w 65d 35H
Inside: 39½w 52d 17H
Standard With Two 20" Throw Pillows



3358-DL
Samuel Left Arm Corner Sofa

99W 41D 39H
Inside: 74W 22D 20H
Arm Height: 25 Seat Height: 19
Loose Pillow Back
Standard With One 20" Throw Pillow
Finish Shown: Walnut

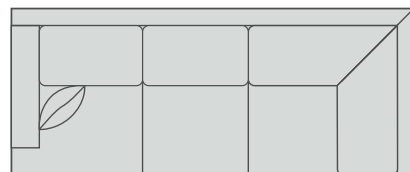

3358-DL
Samuel Left Arm Corner Sofa

99W 41D 39H
Inside: 74W 22D 20H
Standard With One 20" Throw Pillow

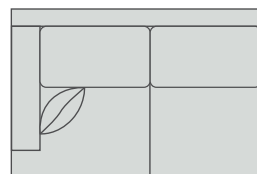

3358-LL
Samuel Left Arm Loveseat

60½W 41D 39H
Inside: 52W 22D 20H
Standard With One 20" Throw Pillow

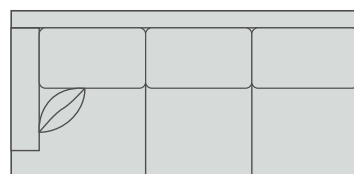

3358-SL
Samuel Left Arm Sofa

85W 41D 39H
Inside: 78W 22D 20H
Standard With One 20" Throw Pillow

3358-LR
Samuel Right Arm Loveseat

60½W 41D 39H
Inside: 52W 22D 20H
Arm Height: 25 Seat Height: 19
Loose Pillow Back
Standard With One 20" Throw Pillow
Finish Shown: Walnut

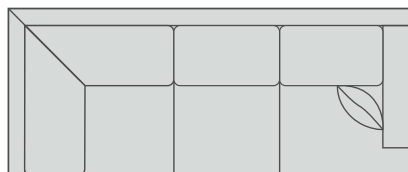

3358-DR
Samuel Right Arm Corner Sofa

99W 41D 39H
Inside: 74W 22D 20H
Standard With One 20" Throw Pillow

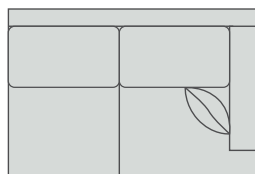

3358-LR
Samuel Right Arm Loveseat

60½W 41D 39H
Inside: 52W 22D 20H
Standard With One 20" Throw Pillow

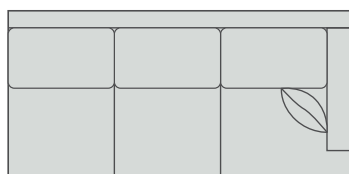

3358-SR
Samuel Right Arm Sofa

85W 41D 39H
Inside: 78W 22D 20H
Standard With One 20" Throw Pillow



PRECEDENT-FURNITURE.COM

Our website not only allows you to search our amazing upholstery items, but includes all inspirational imagery, product specifications, downloadable content, fabrics and more. The site walks through each Studio P Custom Program and is constantly being updated. Visit us today to learn more.

PRINT SECTIONAL DRAWINGS

¼" Scale line drawings are linked to each Sectional product page on our website. Easily print or download these helpful illustrations for use in planning your next design project.

DOWNLOAD STUDIO P ORDER SHEETS

We make ordering any of our custom programs easy with downloadable order sheets that are ready to print, complete and order.

VIEW OVER 500 FABRIC SWATCHES

Sort through our extensive fabric collection with the ability to filter by brand, grade and color. Our full collection and "The Handle" are both available.



TAKE
ADVANTAGE
OF OUR
QR CODES

Save time! Scan QR codes to access product web pages directly.

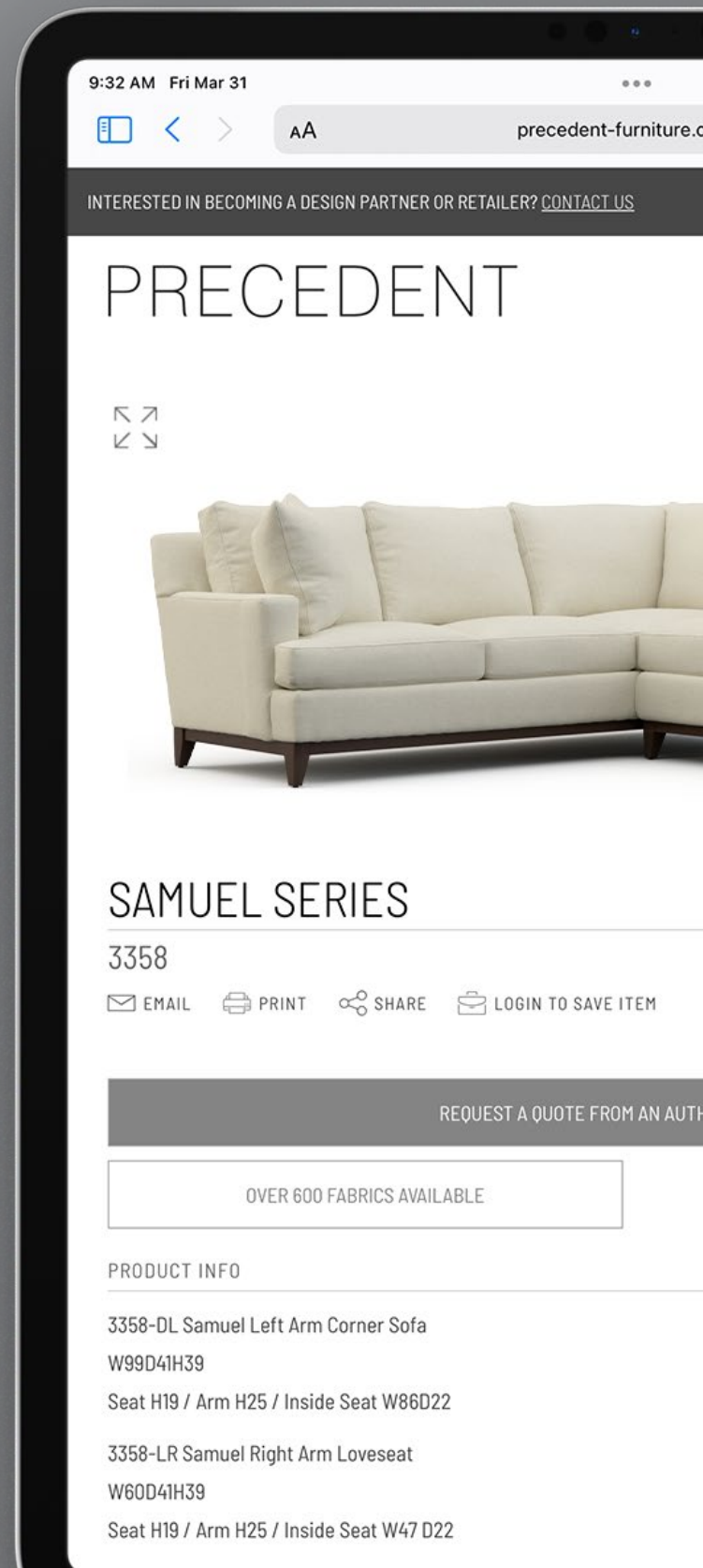



**3364-S2
Arlington Sofa**

97W 39½D 39H
Inside: 84W 22D 21H
Arm Height: 25½ Seat Height:18
Loose Pillow Back
Standard With Two 20" Throw Pillows
Finish Shown: Walnut

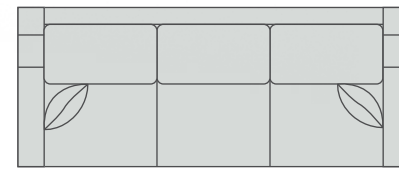

**3364-S2
Arlington Sofa**
97W 39½D 39H
Inside: 84W 22D 21H
Standard With Two 20" Throw Pillows

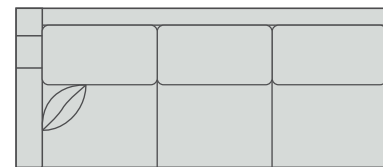

**3364-SL
Arlington Left Arm Sofa**
92W 39½D 39H
Inside: 87W 22D 21H
Standard With One 20" Throw Pillow

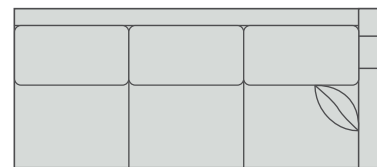

**3364-SR
Arlington Right Arm Sofa**
92W 39½D 39H
Inside: 87W 22D 21H
Standard With One 20" Throw Pillow

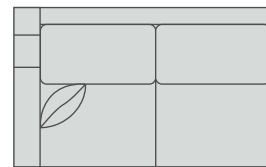

**3364-LL
Arlington Left Arm Loveseat**
63W 39½D 39H
Inside: 58W 22D 21H
Standard With One 20" Throw Pillow

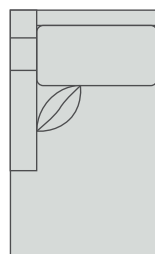

**3364-CL
Arlington Left Arm Chaise**
36W 61D 39H
Inside: 26W 48D 21H
Standard With One 20" Throw Pillow

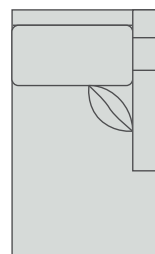

**3364-CR
Arlington Right Arm Chaise**
36W 61D 39H
Inside: 26W 48D 21H
Standard With One 20" Throw Pillow

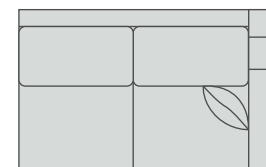

**3364-LR
Arlington Right Arm Loveseat**
63W 39½D 39H
Inside: 58W 22D 21H
Standard With One 20" Throw Pillow

**3371-DL
Sarah Left Arm Corner Sofa**

90W 36D 32½H
Inside: 70W 22D 15½H
Arm Height: 23 Seat Height:17
Loose Pillow Back
Standard With One 20" Throw Pillow
Finish Shown: Walnut



3371-S1 Sarah Sofa
86W 36D 32½H
Inside: 75W 22D 15½H
Standard With Two 20" Throw Pillows

**3371-ER
Sarah Right Arm Chair**

43W 36D 32½H
Inside: 37½W 22D 15½H
Arm Height: 23 Seat Height:17
Loose Pillow Back
Standard With One 20" Throw Pillow
Finish Shown: Walnut

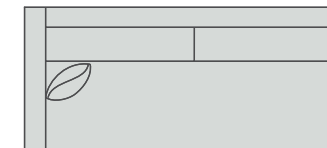

3371-SL Sarah Left Arm Sofa
80½W 36D 32½H
Inside: 75W 22D 15½H
Standard With One 20" Throw Pillow

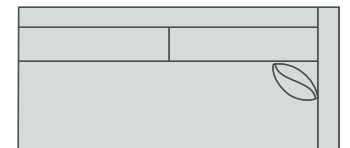

3371-SR Sarah Right Arm Sofa
80½W 36D 32½H
Inside: 75W 22D 15½H
Standard With One 20" Throw Pillow

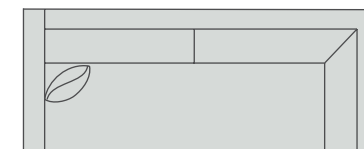

3371-DL Sarah Left Arm Corner Sofa
90W 36D 32½H
Inside: 70W 22D 15½H
Standard With One 20" Throw Pillow

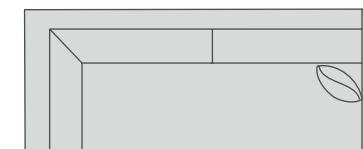

3371-DR Sarah Right Arm Corner Sofa
90W 36D 32½H
Inside: 70W 22D 15½H
Standard With One 20" Throw Pillow

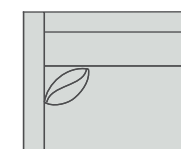

3371-EL Sarah Left Arm Chair
43W 36D 32½H
Inside: 37½W 22D 15½H
Standard With One 20" Throw Pillow

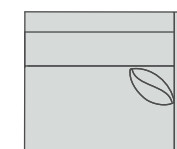

3371-ER Sarah Right Arm Chair
43W 36D 32½H
Inside: 37½W 22D 15½H
Standard With One 20" Throw Pillow

3376-CL Angelina Left Arm Chaise
3376-SR Angelina Right Arm Sofa



3376-CL
Angelina Left Arm Chaise

47W 64D 35H
Inside: 40W 48D 18H
Arm Height: 27 Seat Height:18
Loose Pillow Back
Standard With One 20" Throw Pillow
Finish Shown: Walnut



3376-S2
Angelina Sofa
94½W 37D 35H
Inside: 78W 22D 18H
Standard With Two 20" Throw Pillows

3376-SR
Angelina Right Arm Sofa

86½W 37D 35H
Inside: 78W 22D 18H
Arm Height: 27 Seat Height:18
Loose Pillow Back
Standard With One 20" Throw Pillow
Finish Shown: Walnut

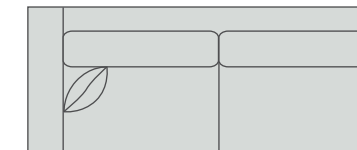

3376-SL
Angelina Left Arm Sofa
86½W 37D 35H
Inside: 78W 22D 18H
Standard With One 20" Throw Pillow

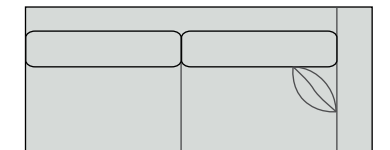

3376-SR
Angelina Right Arm Sofa
86½W 37D 35H
Inside: 78W 22D 18H
Standard With One 20" Throw Pillow

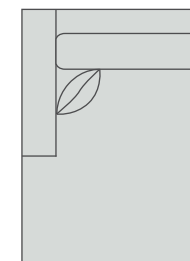

3376-CL
Angelina Left Arm Chaise
47W 64D 35H
Inside: 40W 48D 18H
Standard With One 20" Throw Pillow

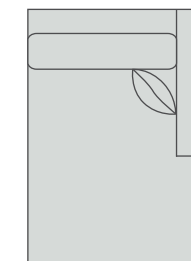

3376-CR
Angelina Right Arm Chaise
47W 64D 35H
Inside: 40W 48D 18H
Standard With One 20" Throw Pillow

3388-BL Renee Left Bumper Chaise
3388-CU Renee Corner Wedge
3388-LR Renee Right Arm Loveseat
4179-C1 Grayson Chair
969-485 Berto Bunching Cube
969-496W Ryker Credenza





3388-SL
Renee Left Arm Sofa

79w 36d 32½h
Inside: 73½w 22d 14½h
Arm Height: 24½ Seat Height: 18
Tight Back
Standard With One 20" Throw Pillow



3388-CU
Renee Wedge

73½w 41d 32½h
Inside: 44½w 22d 14½h
Seat Height: 18
Tight Back



3388-BR
Renee Right Bumper

77½w 36d 32½h
Inside: 72w 22d 14½h
Seat Height: 18
Tight Back



3388-S1
Renee Sofa
88w 36d 32½h
Inside: 77w 22d 14½h
Standard With Two 20" Throw Pillows

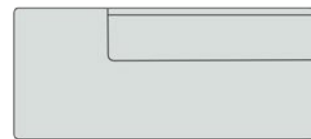

3388-BL
Renee Left Bumper
77½w 36d 32½h
Inside: 72w 22d 14½h



3388-BR
Renee Right Bumper
77½w 36d 32½h
Inside: 72w 22d 14½h



3388-CU
Renee Wedge
73½w 41d 32½h
Inside: 44½w 22d 14½h

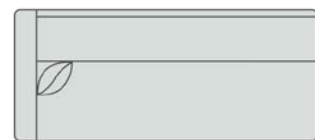

3388-SL
Renee Left Arm Sofa
79w 36d 32½h
Inside: 73½w 22d 14½h
Standard With One 20" Throw Pillow

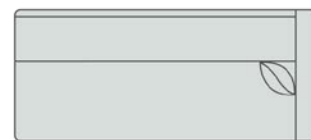

3388-SR
Renee Right Arm Sofa
79w 36d 32½h
Inside: 73½w 22d 14½h
Standard With One 20" Throw Pillow

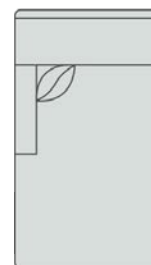

3388-CL
Renee Left Arm Chaise
36½w 65d 32½h
Inside Seat 30½w 50d 14½h
Standard With One 20" Throw Pillow

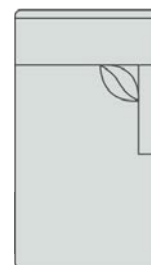

3388-CR
Renee Right Arm Chaise
36½w 65d 32½h
Inside Seat 30½w 50d 14½h
Standard With One 20" Throw Pillow



3388-LL
Renee Left Arm Loveseat
57w 36d 32½h
Inside: 51½w 22d 14½h
Standard With One 20" Throw Pillow



3388-LR
Renee Right Arm Loveseat
57w 36d 32½h
Inside: 51½w 22d 14½h
Standard With One 20" Throw Pillow



3400-SL
Miller Left Arm Sofa

79w 38d 32h
Inside: 71½w 22d 15h
Arm Height: 24 Seat Height: 17
Tight Back
Standard With One 20" Throw Pillow
Finish Shown: Walnut



3400-CR
Miller Right Arm Chaise

43w 69d 32h
Inside: 35½w 53d 15h
Arm Height: 24 Seat Height: 17
Tight Back
Standard With One 20" Throw Pillow
Finish Shown: Walnut

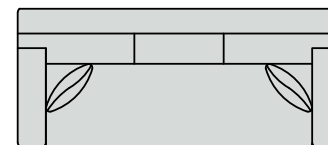

3400-S1
Miller Standard Sofa
86w 38d 32h
Inside: 71w 22d 15h
Standard With Two 20" Throw Pillows

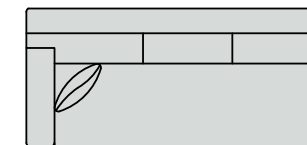

3400-SL
Miller Left Arm Sofa
79w 38d 32h
Inside: 71½w 22d 15h
Standard With One 20" Throw Pillow

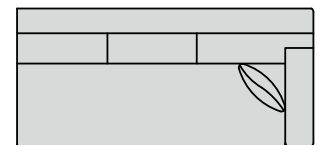

3400-SR
Miller Right Arm Sofa
79w 38d 32h
Inside: 71½w 22d 15h
Standard With One 20" Throw Pillow

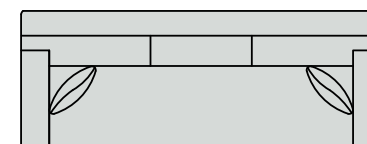

3400-S2
Miller Long Sofa
96w 38d 32h
Inside: 81w 22d 15h
Standard With Two 20" Throw Pillows

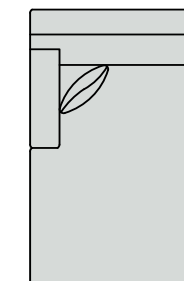

3400-CL
Miller Left Arm Chaise
43w 69d 32h
Inside: 35½w 53d 15h
Standard With One 20" Throw Pillow

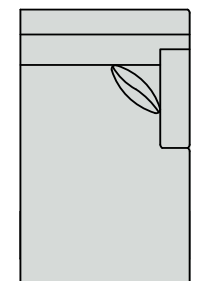

3400-CR
Miller Right Arm Chaise
43w 69d 32h
Inside: 35½w 53d 15h
Standard With One 20" Throw Pillow

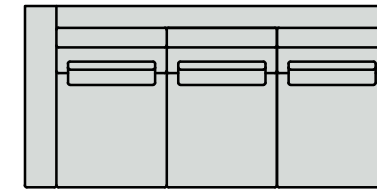

3418-SL
Geneva Left Arm Sofa
 92W 46D 29½H
 Inside: 84W 26D 12H

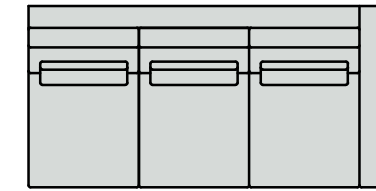

3418-SR
Geneva Right Arm Sofa
 92W 46D 29½H
 Inside: 84W 26D 12H

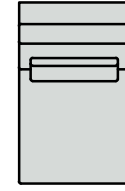

3418-A1
Geneva Armless Chair
 28W 46D 29½H
 Inside: 28W 26D 12H

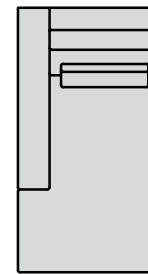

3418-CL
Geneva Left Arm Chaise
 42W 73D 29½H
 Inside: 34W 53D 12H

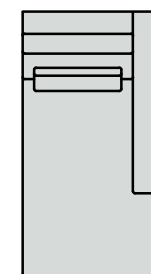

3418-CR
Geneva Right Arm Chaise
 42W 73D 29½H
 Inside: 34W 53D 12H

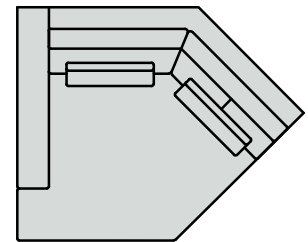

3418-WL
Geneva Left Arm Cuddle Chaise
 73W 59½D 29½H
 Inside: 48W 39½D 12H

3418-WL Geneva Left Arm Cuddle Chaise

73W 59½D 29½H
 Inside: 48W 39½D 12H
 Arm Height: 25½ Seat Height: 18
 Loose Pillow Back
 Finish Shown: Walnut



3418-LO Geneva Armless Loveseat

56W 46D 29½H
 Inside: 56W 26D 12H
 Seat Height: 18
 Loose Pillow Back
 Finish Shown: Walnut



3418-WR Geneva Right Arm Cuddle Chaise

73W 59½D 29½H
 Inside: 48W 39½D 12H
 Arm Height: 25½ Seat Height: 18
 Loose Pillow Back
 Finish Shown: Walnut

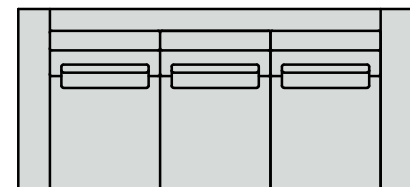

3418-S2
Geneva Long Sofa
 100W 46D 29½H
 Inside: 84W 26D 12H

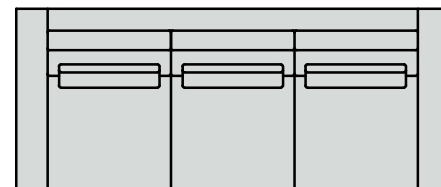

3418-S3
Geneva Extra Long Sofa
 110W 46D 29½H
 Inside: 94W 26D 12H

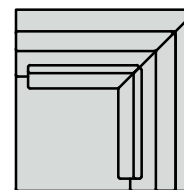

3418-E1
Geneva Corner Chair
 46W 46D 29½H
 Inside: 26W 26D 12H

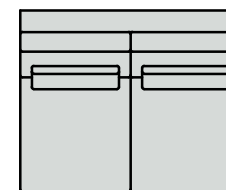

3418-LO
Geneva Armless Loveseat
 56W 46D 29½H
 Inside: 56W 26D 12H

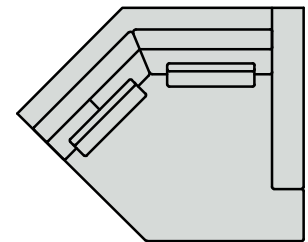

3418-WR
Geneva Right Arm Cuddle Chaise
 73W 59½D 29½H
 Inside: 48W 39½D 12H

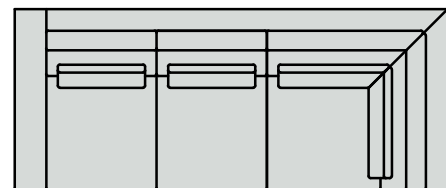

3418-DL
Geneva Left Arm Corner Sofa
 110W 46D 29½H
 Inside: 85W 26D 12H

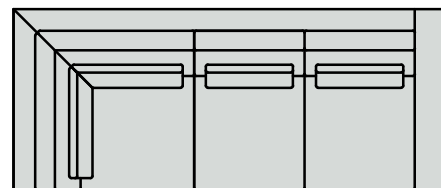

3418-DR
Geneva Right Arm Corner Sofa
 110W 46D 29½H
 Inside: 85W 26D 12H

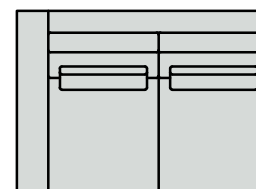

3418-LL
Geneva Left Arm Loveseat
 64W 46D 29½H
 Inside: 56W 26D 12H

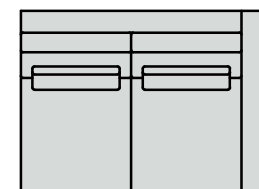

3418-LR
Geneva Right Arm Loveseat
 64W 46D 29½H
 Inside: 56W 26D 12H

3509-C3 Elton Swivel Chair
3438-S1 Banks Sofa
3435-01 Niagara Small Ottoman
MH22321 Luna Side Table
MH33310-90 Birly Coffee Table





**3438-SL
Banks Left Arm Sofa**

76w 41d 36h
Inside: 71w 24d 18h
Arm Height: 25 Seat Height: 18
Loose Pillow Back
Standard With One 20" Throw Pillow

**3438-CR
Banks Right Arm Chaise**

40 1/2w 62d 36h
Inside: 36w 53d 18h
Arm Height: 25 Seat Height: 18
Loose Pillow Back
Standard With One 20" Throw Pillow

**3438-S2
Banks Long Sofa**

96w 41d 36h
Inside: 86 1/2w 24d 18h
Arm Height: 25 Seat Height: 18
Loose Pillow Back
Standard With Two 20" Throw Pillows

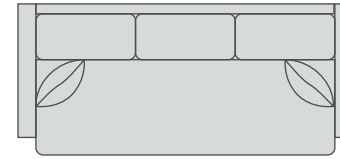

3438-S1 Banks Sofa
84w 41d 36h
Inside: 74 1/2w 24d 18h
Standard With Two 20" Throw Pillows

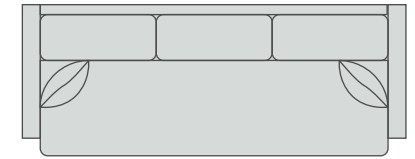

3438-S2 Banks Long Sofa
96w 41d 36h
Inside: 86 1/2w 24d 18h
Standard With Two 20" Throw Pillows

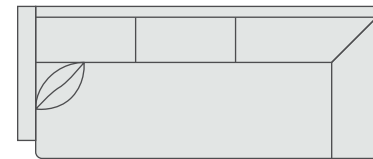

3438-DL Banks Left Arm Corner Sofa
100w 41d 36h
Inside: 81 1/2w 24d 18h
Standard With One 20" Throw Pillow



3438-DR Banks Right Arm Corner Sofa
100w 41d 36h
Inside: 81 1/2w 24d 18h
Standard With One 20" Throw Pillow

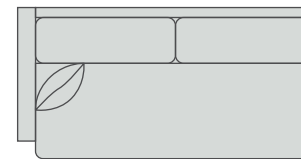

3438-SL Banks Left Arm Sofa
76w 41d 36h
Inside: 71w 24d 18h
Standard With One 20" Throw Pillow

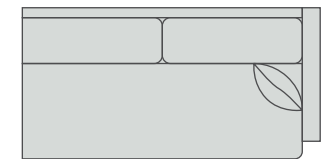

3438-SR Banks Right Arm Sofa
76w 41d 36h
Inside: 71w 24d 18h
Standard With One 20" Throw Pillow



3438-LO Banks Armless Loveseat
61 1/2w 41d 36h
Inside: 61 1/2w 24d 18h

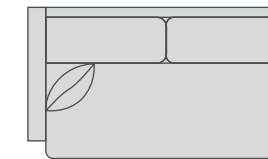

3438-LL Banks Left Arm Loveseat
66w 41d 36h
Inside: 61w 24d 18h
Standard With One 20" Throw Pillow

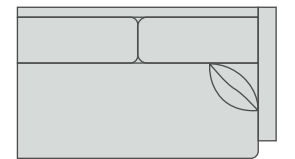

3438-LR Banks Right Arm Loveseat
66w 41d 36h
Inside: 61w 24d 18h
Standard With One 20" Throw Pillow

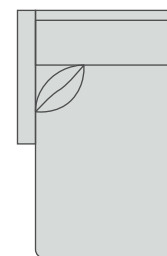

3438-CL Banks Left Arm Chaise
40 1/2w 62d 36h
Inside: 36w 53d 18h
Standard With One 20" Throw Pillow

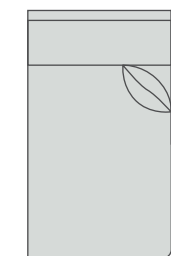

3438-CR Banks Right Arm Chaise
40 1/2w 62d 36h
Inside: 36w 53d 18h
Standard With One 20" Throw Pillow

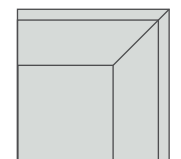

3438-E1 Banks Inside Corner
40 1/2w 40 1/2d 36h
Inside: 24w 24d 18h

**3450-S1
Martin Sofa**

88½w 38d 33h
 Inside: 79½w 22d 15h
 Arm Height: 24½ Seat Height: 18
 Loose Pillow Back
 Standard With Two 20" Throw Pillows
 Finish Shown: Walnut

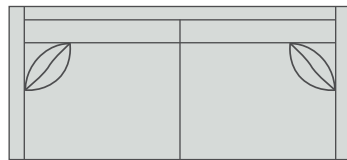

**3450-S1
Martin Sofa**
 88½w 38d 33h
 Inside: 79½w 22d 15h
 Standard With Two 20" Throw Pillows

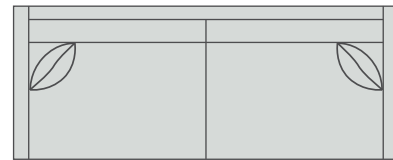

**3450-S2
Martin Long Sofa**
 93½w 38d 33h
 Inside: 84w 22d 15h
 Standard With Two 20" Throw Pillows

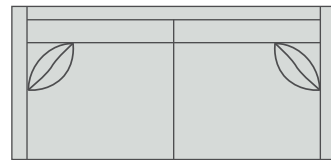

**3450-B1
Martin Short Sofa**
 75½w 38d 33h
 Inside: 69½w 22d 15h
 Standard With Two 20" Throw Pillows



**3450-SL
Martin Left Arm Sofa**
 82½w 38d 33h
 Inside: 79½w 22d 15h
 Standard With One 20" Throw Pillow

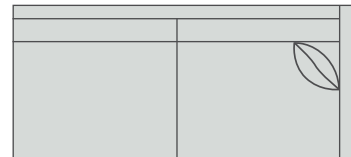

**3450-SR
Martin Right Arm Sofa**
 82½w 38d 33h
 Inside: 79½w 22d 15h
 Standard With One 20" Throw Pillow



**3450-S0
Martin Armless Sofa**
 80w 38d 33h
 Inside: 80w 22d 15h



**3450-DL
Martin Left Arm Corner Sofa**
 94w 38d 33h
 Inside: 79½w 22d 15h
 Standard With One 20" Throw Pillow



**3450-DR
Martin Right Arm Corner Sofa**
 94w 38d 33h
 Inside: 79½w 22d 15h
 Standard With One 20" Throw Pillow

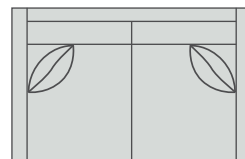

**3450-L1
Martin Loveseat**
 60w 38d 33h
 Inside: 53w 22d 15h
 Standard With Two 20" Throw Pillows

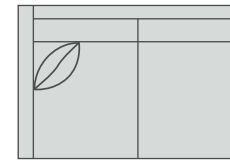

**3450-LL
Martin Left Arm Loveseat**
 56w 38d 33h
 Inside: 53w 22d 15h
 Standard With One 20" Throw Pillow

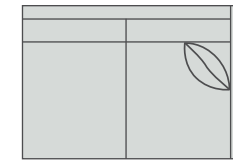

**3450-LR
Martin Right Arm Loveseat**
 56w 38d 33h
 Inside: 53w 22d 15h
 Standard With One 20" Throw Pillow

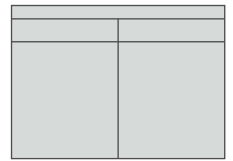

**3450-LO
Martin Armless Loveseat**
 53½w 38d 33h
 Inside: 53½w 22d 15h

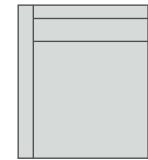

**3450-C1
Martin Chair**
 32½w 38d 33h
 Inside: 26½w 22d 15h



**3450-EL
Martin Left Arm Chair**
 29½w 38d 33h
 Inside: 26½w 22d 15h
 Standard With One 20" Throw Pillow

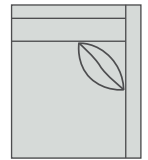

**3450-ER
Martin Right Arm Chair**
 29½w 38d 33h
 Inside: 26½w 22d 15h
 Standard With One 20" Throw Pillow

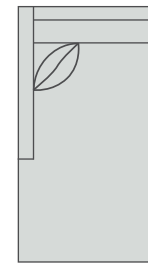

**3450-CL
Martin Left Arm Chaise**
 33w 64d 33h
 Inside: 30w 49d 15h
 Standard With One 20" Throw Pillow

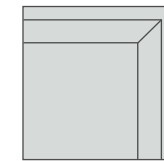

**3450-E1
Martin Inside Corner**
 38w 38d 33h
 Inside: 22w 22d 15h

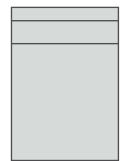

**3450-A1
Martin Armless Chair**
 27w 38d 33h
 Inside: 27w 22d 15h



**3450-CR
Martin Right Arm Chaise**
 33w 64d 33h
 Inside: 30w 49d 15h
 Standard With One 20" Throw Pillow

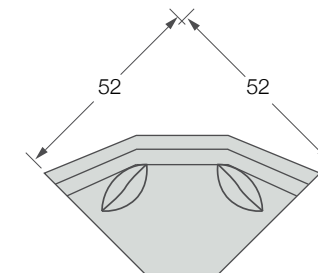

**3450-CU
Martin Wedge**
 73½w 41d 33h
 Inside: 42w 22d 15h
 Standard With Two 20" Throw Pillows



**3450-O1
Martin Ottoman**
 28w 23d 17h

3458-S1 Arlo Sofa
L3531-C1 Tuttle Leather Chair
SER-090 Olin Round Cocktail Table
SER-010 Olin Round End Table





3458-DL
Arlo Left Arm Corner Sofa

122W 38D 32H
Inside: 101W 24D 16H
Arm Height: 24½ Seat Height: 16
Loose Pillow Back
Standard With One 20" Throw Pillow

3458-SR
Arlo Right Arm Sofa

84½W 38D 32H
Inside: 77W 24D 16H
Arm Height: 24½ Seat Height: 16
Loose Pillow Back
Standard With One 20" Throw Pillow

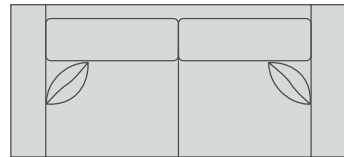

3458-S1
Arlo Sofa
84W 38D 32H
Inside: 66W 24D 16H
Standard With Two 20" Throw Pillows

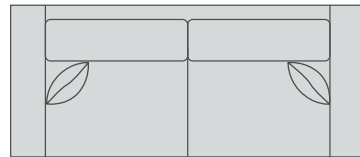

3458-S2
Arlo Long Sofa
89W 38D 32H
Inside: 74W 24D 16H
Standard With Two 20" Throw Pillows



3458-DL
Arlo Left Arm Corner Sofa
122W 38D 32H
Inside: 101W 24D 16H
Standard With One 20" Throw Pillow



3458-SL
Arlo Left Arm Corner Sofa
84½W 38D 32H
Inside: 77W 24D 16H
Standard With One 20" Throw Pillow

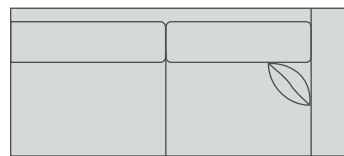

3458-SR
Arlo Right Arm Corner Sofa
84½W 38D 32H
Inside: 77W 24D 16H
Standard With One 20" Throw Pillow



3458-DR
Arlo Right Arm Corner Sofa
122W 38D 32H
Inside: 101W 24D 16H
Standard With One 20" Throw Pillow



3483-A1
Fleetwood Armless Chair

30½W 34½D 30H
Inside: 31W 23D 13H
Seat Height: 17
Tight Buttoned Back & Seat



3483-E1
Fleetwood Corner Chair

34½W 34½D 30H
Inside: 23W 23D 13H
Seat Height: 17
Tight Buttoned Back & Seat

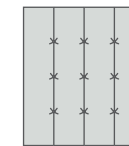

3483-01
Fleetwood Ottoman
30W 34½D 17H



3483-A1
Fleetwood Armless Chair
30½W 34½D 30H
Inside: 30½W 23D 13H

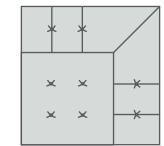

3483-E1
Fleetwood Corner Chair
34½W 34½D 30H
Inside: 23W 23D 13H



3483-01
Fleetwood Ottoman

30W 34½D 17H
Tight Buttoned Top



L3483-01 Fleetwood Leather Ottoman
L3483-A1 Fleetwood Armless Chair
L3483-E1 Fleetwood Corner Chair
L3483-A1 Fleetwood Armless Chair
L3483-E1 Fleetwood Corner Chair
3473-C3 Exeter Swivel Chair





**3565-SL
Newman Left
Arm Sofa**

92W 40D 34H
Inside: 82½W 24D 17H
Arm Height: 24 Seat Height: 17
Loose Pillow Back
Standard With One 20" Throw Pillow
Finish Shown: Walnut

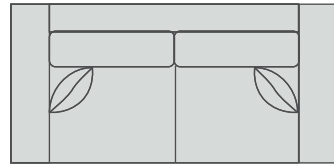

**3565-S1
Newman Short Sofa**
82W 40D 34H
Inside: 63W 24D 17H
Standard With Two 20" Throw Pillows

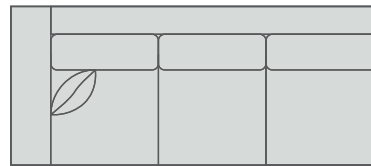

**3565-SL
Newman Left Arm Sofa**
92W 40D 34H
Inside: 82½W 24D 17H
Standard With One 20" Throw Pillow



**3565-JR
Newman Right Arm Wide Loveseat**
83W 40D 34H
Inside: 73½W 24D 17H
Standard With One 20" Throw Pillow
Married to 3565-KL

**3565-E1
Newman
Inside Corner**

40W 40D 34H
Inside: 24W 24D 17H
Seat Height: 17
Loose Pillow Back
Finish Shown: Walnut

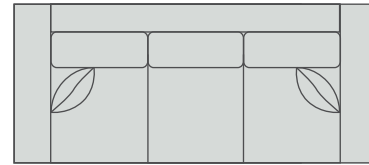

**3565-S2
Newman Standard Sofa**
91W 40D 34H
Inside: 72W 24D 17H
Standard With Two 20" Throw Pillows

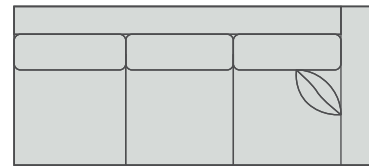

**3565-SR
Newman Right Arm Sofa**
92W 40D 34H
Inside: 82½W 24D 17H
Standard With One 20" Throw Pillow

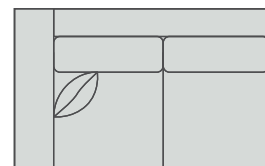

**3565-LL
Newman Left Arm Loveseat**
64W 40D 34H
Inside: 54½W 24D 17H
Standard With One 20" Throw Pillow

**3565-L0
Newman Armless
Standard Loveseat**

66W 40D 34H
Inside: 66W 24D 17H
Seat Height: 17
Loose Pillow Back
Finish Shown: Walnut

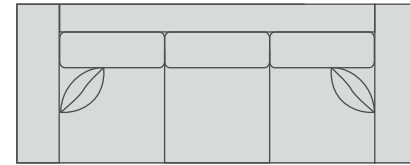

**3565-S3
Newman Long Sofa**
100W 40D 34H
Inside: 81W 24D 17H
Standard With Two 20" Throw Pillows

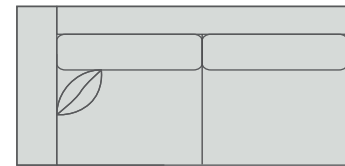

**3565-JL
Newman Left Arm Wide Loveseat**
83W 40D 34H
Inside: 73½W 24D 17H
Standard With One 20" Throw Pillow
Married to 3565-KR

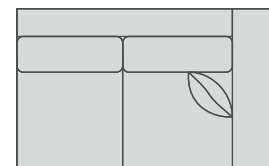

**3565-LR
Newman Right Arm Loveseat**
64W 40D 34H
Inside: 54½W 24D 17H
Standard With One 20" Throw Pillow

**3565-CA
Newman Armless
Chaise**

32W 67½D 34H
Inside: 32W 51½D 17H
Seat Height: 17
Loose Pillow Back
Finish Shown: Walnut

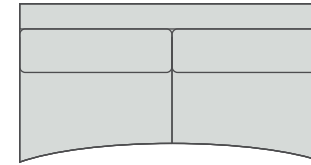

**3565-S0
Newman Armless Shaped Sofa**
76½W 40D 34H
Inside: 76½W 24D 17H



**3565-A1
Newman Armless Chair**
28W 40D 34H
Inside: 28W 24D 17H

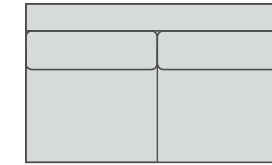

**3565-L0
Newman Armless Standard
Loveseat**
66W 40D 34H
Inside: 66W 24D 17H



**3565-B0
Newman Armless
Short Loveseat**
56W 40D 34H
Inside: 56W 24D 17H

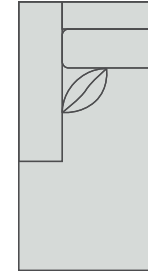

**3565-CL
Newman Left Arm Chaise**
36W 67½D 34H
Inside: 26½W 51½D 17H
Standard With One 20" Throw Pillow

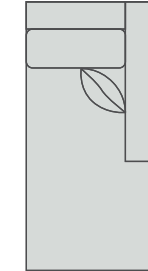

**3565-CR
Newman Right Arm Chaise**
36W 67½D 34H
Inside: 26½W 51½D 17H
Standard With One 20" Throw Pillow

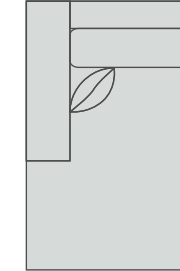

**3565-KL
Newman Left Arm
Chaise**
45W 67½D 34H
Inside: 35½W 51½D 17H
Standard With One 20" Throw Pillow
Married to 3565-JR

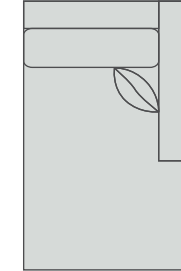

**3565-KR
Newman Right
Arm Chaise**
45W 67½D 34H
Inside: 35½W 51½D 17H
Standard With One 20" Throw Pillow
Married to 3565-JL

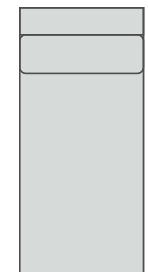

**3565-CA
Newman Armless Chaise**
32W 67½D 34H
Inside: 32W 51½D 17H

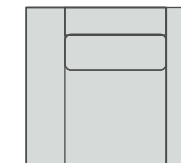

**3565-C1
Newman Chair**
45W 40D 34H
Inside: 26W 24D 17H

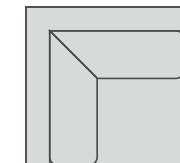

**3565-E1
Newman Inside Corner**
40W 40D 34H
Inside: 24W 24D 17H

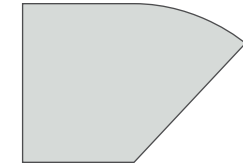

**3565-BL
Newman Left
Bumper Ottoman**
56W 40D 17H

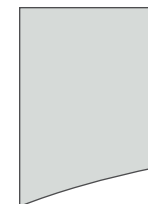

**3565-L04
Newman Left
Shaped Ottoman**
35W 50D 17H

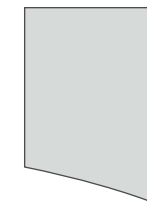

**3565-R04
Newman Right
Shaped Ottoman**
35W 50D 17H

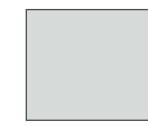

**3565-01
Newman Ottoman**
40W 28D 17H

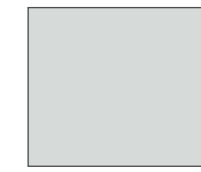

**3565-03
Newman Ottoman & 1/2**
50W 40D 17H

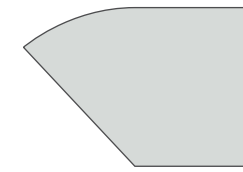

**3565-BR
Newman Right
Bumper Ottoman**
56W 40D 17H

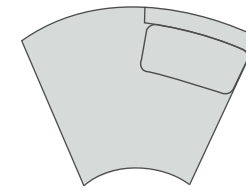

3566-CCL
Clifton Curved Chaise Left
62W 45D 34H
Inside: 52W 24D 17H

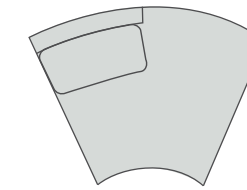

3566-CCR
Clifton Curved Chaise Right
62W 45D 34H
Inside: 52W 24D 17H

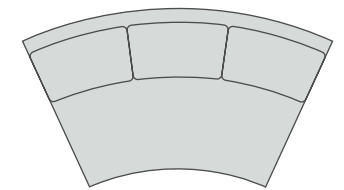

3566-CSO
Clifton Curved Armless Sofa
78W 45D 34H
Inside: 46W 24D 17H

3566-CBL
Clifton Curved Left Arm Bumper

81W 45D 34H
Inside: 65W 24D 17H
Arm Height: 24 Seat Height: 17
Loose Pillow Back
Finish Shown: Walnut

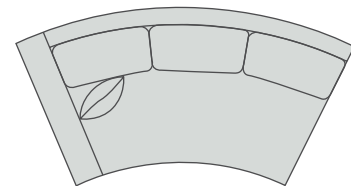

3566-CSL
Clifton Curved Left Arm Sofa
85W 45D 34H
Inside: 75½W 24D 17H
Standard With One 20" Throw Pillow

3566-CSR
Clifton Curved Right Arm Sofa

85W 45D 34H
Inside: 75½W 24D 17H
Arm Height: 24 Seat Height: 17
Loose Pillow Back
Standard With One 20" Throw Pillow
Finish Shown: Walnut

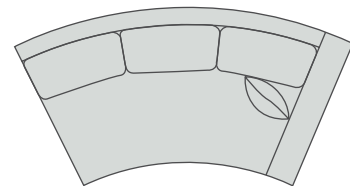

3566-CSR
Clifton Curved Right Arm Sofa
85W 45D 34H
Inside: 75½W 24D 17H
Standard With One 20" Throw Pillow

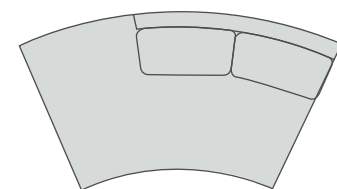

3566-CBL
Clifton Curved Left Arm Bumper
81W 45D 34H
Inside: 65W 24D 17H

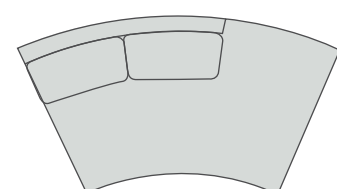

3566-CBR
Clifton Curved Right Arm Bumper
81W 45D 34H
Inside: 65W 24D 17H

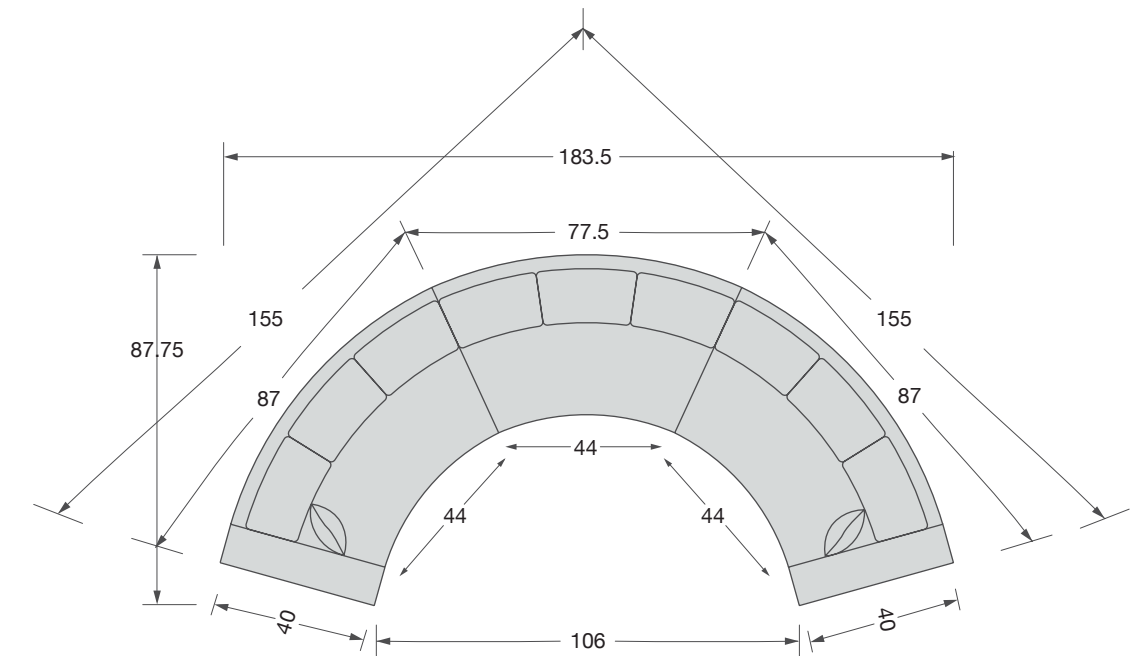

3566-CSL Clifton Curved Left Arm Sofa
3566-CSO Clifton Curved Armless Sofa
3566-CSR Clifton Curved Right Arm Sofa

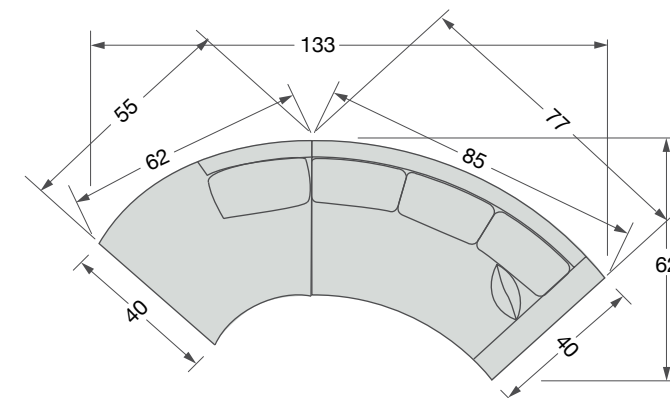

3566-CCL Clifton Curved Chaise Left
3566-CSR Clifton Curved Right Arm Sofa

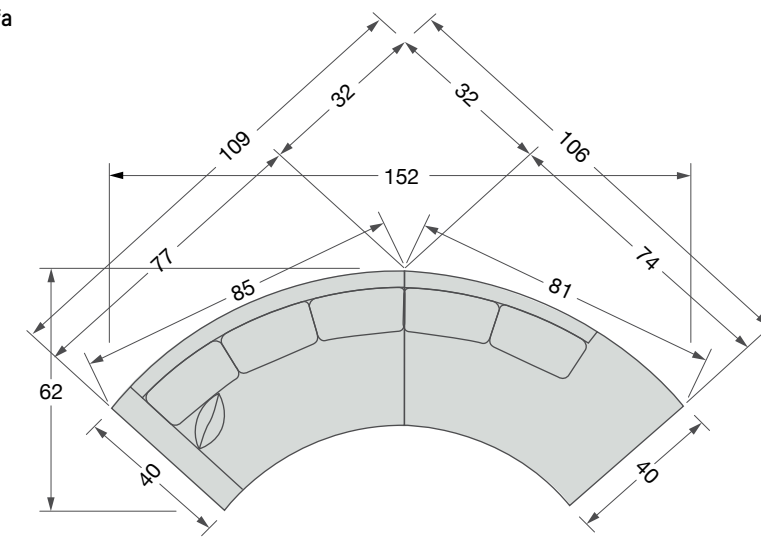

3566-CSL Clifton Curved Left Arm Sofa
3566-CBR Clifton Curved Right Arm Bumper



3567-SL
Larabee Left Arm Sofa

92W 40D 34H
Inside: 82½W 24D 17H
Arm Height: 24 Seat Height: 17
Loose Pillow Back
Standard With One 20" Throw Pillow
Finish Shown: Walnut

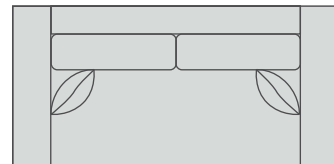

3567-S1
Larabee Short Sofa
82W 40D 34H
Inside: 63W 24D 17H
Standard With Two 20" Throw Pillows

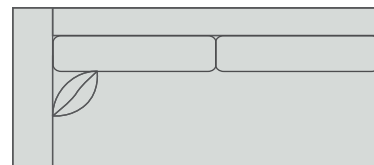

3567-SL
Larabee Left Arm Sofa
92W 40D 34H
Inside: 82½W 24D 17H
Standard With One 20" Throw Pillow

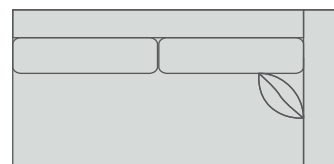

3567-JR
Larabee Right Arm Wide Loveseat
83W 40D 34H
Inside: 73½W 24D 17H
Standard With One 20" Throw Pillow
Married to 3567-KL

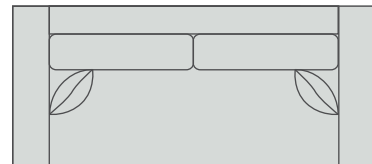

3567-S2
Larabee Standard Sofa
91W 40D 34H
Inside: 72W 24D 17H
Standard With Two 20" Throw Pillows

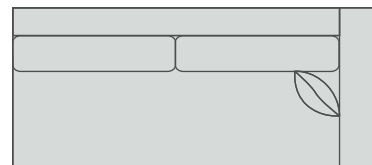

3567-SR
Larabee Right Arm Sofa
92W 40D 34H
Inside: 82½W 24D 17H
Standard With One 20" Throw Pillow

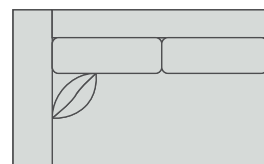

3567-LL
Larabee Left Arm Loveseat
64W 40D 34H
Inside: 54½W 24D 17H
Standard With One 20" Throw Pillow

3567-CR
Larabee Right Arm Chaise

36W 67½D 34H
Inside: 26½W 51½D 17H
Arm Height: 24 Seat Height: 17
Loose Pillow Back
Standard With One 20" Throw Pillow
Finish Shown: Walnut

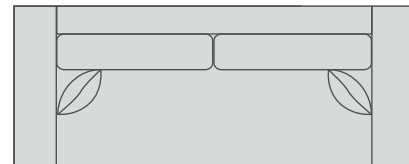

3567-S3
Larabee Long Sofa
100W 40D 34H
Inside: 81W 24D 17H
Standard With Two 20" Throw Pillows

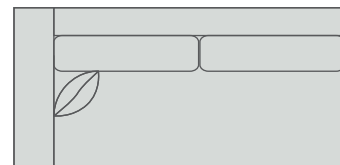

3567-JL
Larabee Left Arm Wide Loveseat
83W 40D 34H
Inside: 73½W 24D 17H
Standard With One 20" Throw Pillow
Married to 3567-KR

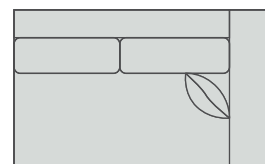

3567-LR
Larabee Right Arm Loveseat
64W 40D 34H
Inside: 54½W 24D 17H
Standard With One 20" Throw Pillow

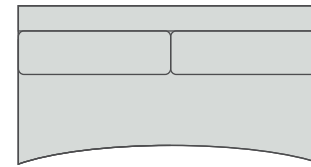

3567-S0
Larabee Armless Shaped Sofa
76½W 40D 34H
Inside: 76½W 24D 17H



3567-A1
Larabee Armless Chair
28W 40D 34H
Inside: 28W 24D 17H

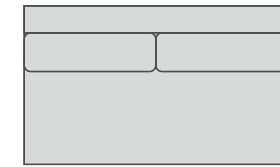

3567-L0
Larabee Armless Standard Loveseat
66W 40D 34H
Inside: 66W 24D 17H

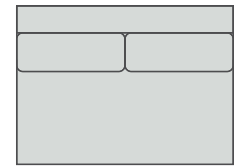

3567-B0
Larabee Armless Short Loveseat
56W 40D 34H
Inside: 56W 24D 17H

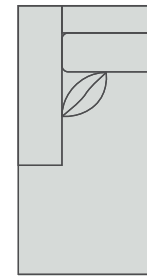

3567-CL
Larabee Left Arm Chaise
36W 67½D 34H
Inside: 26½W 51½D 17H
Standard With One 20" Throw Pillow

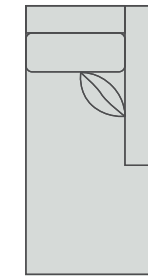

3567-CR
Larabee Right Arm Chaise
36W 67½D 34H
Inside: 26½W 51½D 17H
Standard With One 20" Throw Pillow

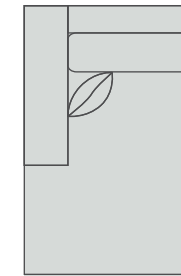

3567-KL
Larabee Left Arm Chaise
45W 67½D 34H
Inside: 35½W 51½D 17H
Standard With One 20" Throw Pillow
Married to 3567-JR

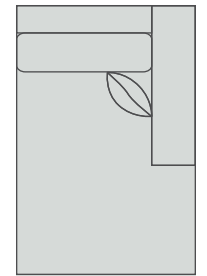

3567-KR
Larabee Right Arm Chaise
45W 67½D 34H
Inside: 26½W 51½D 17H
Standard With One 20" Throw Pillow
Married to 3567-JL



3567-CA
Larabee Armless Chaise
32W 67½D 34H
Inside: 32W 51½D 17H

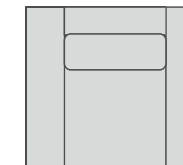

3567-C1
Larabee Chair
45W 40D 34H
Inside: 26W 24D 17H

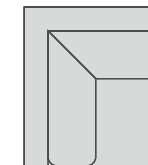

3567-E1
Larabee Inside Corner
40W 40D 34H
Inside: 24W 24D 17H

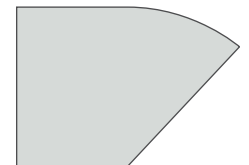

3567-BL
Larabee Left Bumper Ottoman
56W 40D 17H

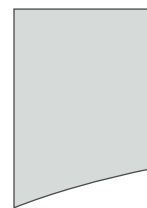

3567-L04
Larabee Left Shaped Ottoman
35W 50D 17H

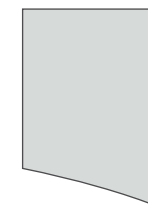

3567-R04
Larabee Right Shaped Ottoman
35W 50D 17H



3567-01
Larabee Ottoman
40W 28D 17H



3567-03
Larabee Ottoman & 1/2
50W 40D 17H

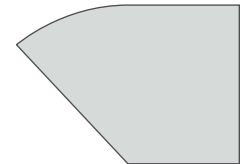

3567-BR
Larabee Right Bumper Ottoman
56W 40D 17H

3568-S3 Clavin Sofa
3519-C1 Hollie Chair
MH25322-91 Ratean Spot Table



CLAVIN SERIES SECTIONAL | Precedent



3568-SL Clavin Left Arm Sofa

92W 40D 34H
Inside: 82½W 24D 17H
Arm Height: 24 Seat Height: 17
Loose Pillow Back
Standard With One 20" Throw Pillow
Finish Shown: Walnut

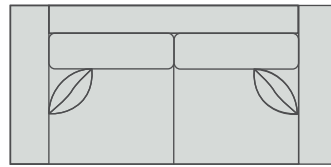

3568-S1 Clavin Short Sofa

82W 40D 34H
Inside: 63W 24D 17H
Standard With Two 20" Throw Pillows

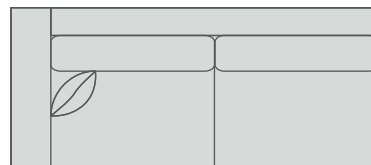

3568-SL Clavin Left Arm Sofa

92W 40D 34H
Inside: 82½W 24D 17H
Standard With One 20" Throw Pillow

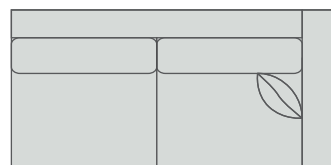

3568-JR Clavin Right Arm Wide Loveseat

83W 40D 34H
Inside: 73½W 24D 17H
Standard With One 20" Throw Pillow
Married to 3568-KL

3568-E1 Clavin Inside Corner

40W 40D 34H
Inside: 24W 24D 17H
Seat Height: 17
Loose Pillow Back
Finish Shown: Walnut

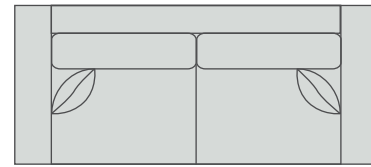

3568-S2 Clavin Standard Sofa

91W 40D 34H
Inside: 72W 24D 17H
Standard With Two 20" Throw Pillows

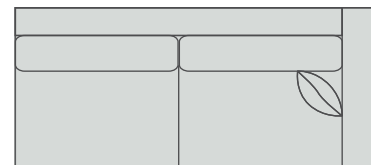

3568-SR Clavin Right Arm Sofa

92W 40D 34H
Inside: 82½W 24D 17H
Standard With One 20" Throw Pillow

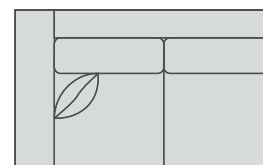

3568-LL Clavin Left Arm Loveseat

64W 40D 34H
Inside: 54½W 24D 17H
Standard With One 20" Throw Pillow

3568-LO Clavin Armless Standard Loveseat

66W 40D 34H
Inside: 66W 24D 17H
Seat Height: 17
Loose Pillow Back
Finish Shown: Walnut

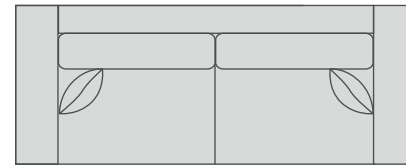

3568-S3 Clavin Long Sofa

100W 40D 34H
Inside: 81W 24D 17H
Standard With Two 20" Throw Pillows

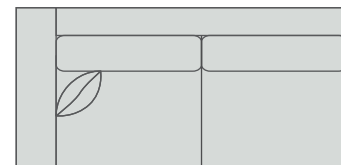

3568-JL Clavin Left Arm Wide Loveseat

83W 40D 34H
Inside: 73½W 24D 17H
Standard With One 20" Throw Pillow
Married to 3568-KR

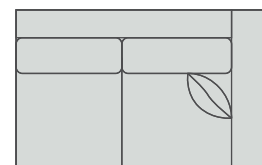

3568-LR Clavin Right Arm Loveseat

64W 40D 34H
Inside: 54½W 24D 17H
Standard With One 20" Throw Pillow

3568-CA Clavin Armless Chaise

32W 67½D 34H
Inside: 32W 51½D 17H
Seat Height: 17
Loose Pillow Back
Finish Shown: Walnut

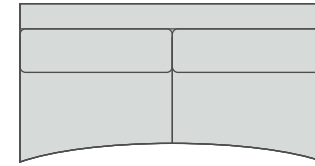

3568-S0 Clavin Armless Shaped Sofa

76½W 40D 34H
Inside: 76½W 24D 17H



3568-A1 Clavin Armless Chair

28W 40D 34H
Inside: 28W 24D 17H

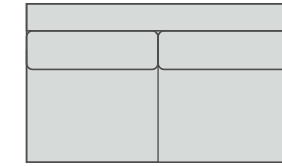

3568-LO Clavin Armless Standard Loveseat

66W 40D 34H
Inside: 66W 24D 17H

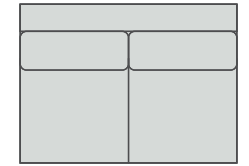

3568-B0 Clavin Armless Short Loveseat

56W 40D 34H
Inside: 56W 24D 17H

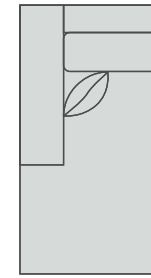

3568-CL Clavin Left Arm Chaise

36W 67½D 34H
Inside: 26½W 51½D 17H
Standard With One 20" Throw Pillow

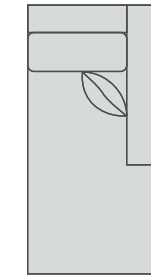

3568-CR Clavin Right Arm Chaise

36W 67½D 34H
Inside: 26½W 51½D 17H
Standard With One 20" Throw Pillow

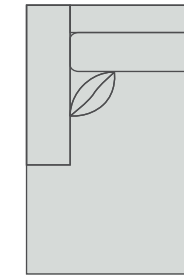

3568-KL Clavin Left Arm Chaise

45W 67½D 34H
Inside: 35½W 51½D 17H
Standard With One 20" Throw Pillow
Married to 3568-JR

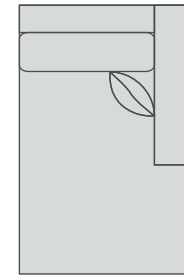

3568-KR Clavin Right Arm Chaise

45W 67½D 34H
Inside: 35½W 51½D 17H
Standard With One 20" Throw Pillow
Married to 3568-JL



3568-CA Clavin Armless Chaise

32W 67½D 34H
Inside: 32W 51½D 17H

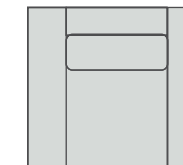

3568-C1 Clavin Chair

45W 40D 34H
Inside: 26W 24D 17H

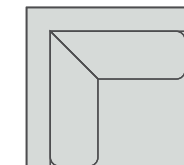

3568-E1 Clavin Inside Corner

40W 40D 34H
Inside: 24W 24D 17H

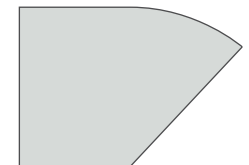

3568-BL Clavin Left Bumper Ottoman

56W 40D 17H



3568-L04 Clavin Left Shaped Ottoman

35W 50D 17H

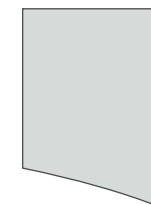

3568-R04 Clavin Right Shaped Ottoman

35W 50D 17H



3568-O1 Clavin Ottoman

40W 28D 17H



3568-O3 Clavin Ottoman & 1/2

50W 40D 17H

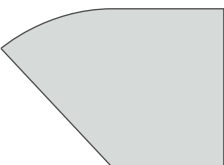

3568-BR Clavin Right Bumper Ottoman

56W 40D 17H



4125-S1
Keaton Mid Length Sofa

79w 35d 31h
Inside: 67w 21d 13h
Arm Height: 26 Seat Height: 18
Tight Back
Standard With Two 20" Throw Pillows
Finish Shown: Walnut



4125-S1
Keaton Mid-Length Sofa
79w 35d 31h
Inside: 67w 21d 13h
Standard With Two 20" Throw Pillows



4125-S2
Keaton Sofa
86w 35d 31h
Inside: 74w 21d 13h
Standard With Two 20" Throw Pillows



4125-B1
Keaton Short Sofa
72w 35d 31h
Inside: 60w 21d 13h
Standard With Two 20" Throw Pillows

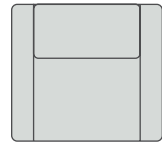

4125-C1
Keaton Chair
38w 35d 31h
Inside: 26w 21d 13h

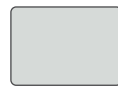

4125-O1
Keaton Ottoman
28w 22d 16½h



4125-SL
Keaton Left Arm Sofa
81w 35d 31h
Inside: 75w 21d 13h
Standard With One 20" Throw Pillow

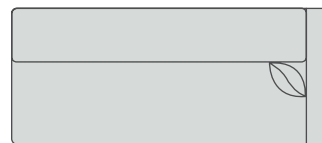

4125-SR
Keaton Right Arm Sofa
81w 35d 31h
Inside: 75w 21d 13h
Standard With One 20" Throw Pillow

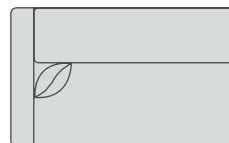

4125-LL
Keaton Left Arm Loveseat
56w 35d 31h
Inside: 50w 21d 13h
Standard With One 20" Throw Pillow

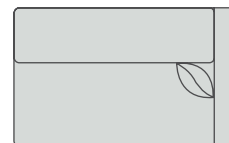

4125-LR
Keaton Right Arm Loveseat
56w 35d 31h
Inside: 50w 21d 13h
Standard With One 20" Throw Pillow



4125-BL
Keaton Angled Left Bumper

68w 35d 31h
Inside: 58w 21d 13h
Seat Height: 18
Tight Back
Finish Shown: Walnut



4125-DL
Keaton Left Arm Corner Sofa
93w 35d 31h
Inside: 78w 21d 13h
Standard With One 20" Throw Pillow

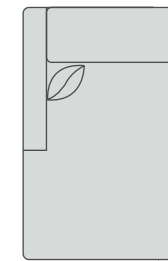

4125-CL
Keaton Left Arm Chaise
40w 63½d 31h
Inside: 38w 52d 13h
Standard With One 20" Throw Pillow



4125-BL
Keaton Angled Left Bumper
68w 35d 31h
Inside: 58w 21d 13h
Married to 4125-ALR

4125-ALR
Keaton Angled Right Arm Loveseat

67w 35d 31h
Inside: 52w 21d 13h
Arm Height: 26 Seat Height: 18
Tight Back
Standard With One 20" Throw Pillow
Finish Shown: Walnut

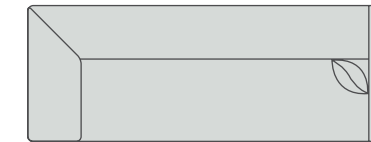

4125-DR
Keaton Right Arm Corner Sofa
93w 35d 31h
Inside: 78w 21d 13h
Standard With One 20" Throw Pillow

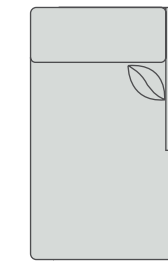

4125-CR
Keaton Right Arm Chaise
40w 63½d 31h
Inside: 38w 52d 13h
Standard With One 20" Throw Pillow

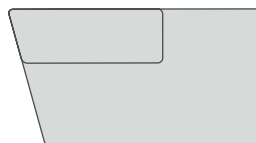

4125-BR
Keaton Angled Right Bumper
68w 35d 31h
Inside: 58w 21d 13h
Married to 4125-ALL

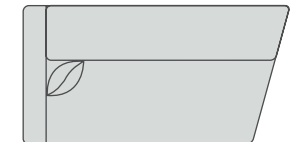

4125-ALL
Keaton Angled Left Arm Loveseat
67w 35d 31h
Inside: 52w 21d 13h
Standard With One 20" Throw Pillow
Married to 4125-BR

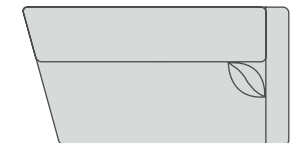

4125-ALR
Keaton Angled Right Arm Loveseat
67w 35d 31h
Inside: 52w 21d 13h
Standard With One 20" Throw Pillow
Married to 4125-BL



4365-LL Astor Left Arm Loveseat

64w 40d 34h
 Inside: 54½w 24d 17h
 Arm Height: 24 Seat Height: 17
 Standard With One 20" Throw Pillow
 Loose Pillow Back
 Finish Shown: Walnut

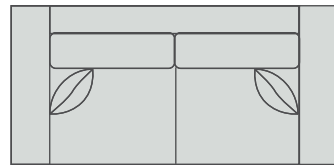

4365-S1 Astor Short Sofa
 82w 40d 34h
 Inside: 63w 24d 17h
 Standard With Two 20" Throw Pillows



4365-SL Astor Left Arm Sofa
 92w 40d 34h
 Inside: 82½w 24d 17h
 Standard With One 20" Throw Pillow

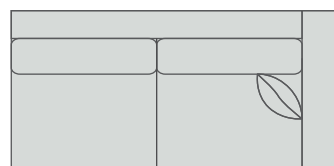

4365-JR Astor Right Arm Wide Loveseat
 83w 40d 34h
 Inside: 73½w 24d 17h
 Standard With One 20" Throw Pillow
 Married to 4365-KL

4365-E1 Astor Inside Corner

40w 40d 34h
 Inside: 24w 24d 17h
 Seat Height: 17
 Loose Pillow Back
 Finish Shown: Walnut

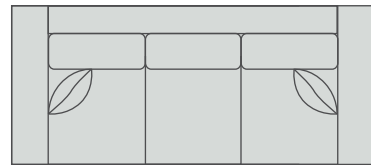

4365-S2 Astor Standard Sofa
 91w 40d 34h
 Inside: 72w 24d 17h
 Standard With Two 20" Throw Pillows

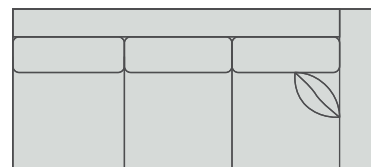

4365-SR Astor Right Arm Sofa
 92w 40d 34h
 Inside: 82½w 24d 17h
 Standard With One 20" Throw Pillow

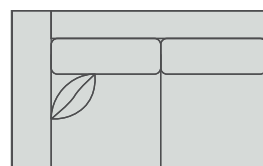

4365-LL Astor Left Arm Loveseat
 64w 40d 34h
 Inside: 54½w 24d 17h
 Standard With One 20" Throw Pillow

4365-SR Astor Right Arm Sofa

92w 40d 34h
 Inside: 82½w 24d 17h
 Arm Height: 24 Seat Height: 17
 Standard With One 20" Throw Pillow
 Loose Pillow Back
 Finish Shown: Walnut

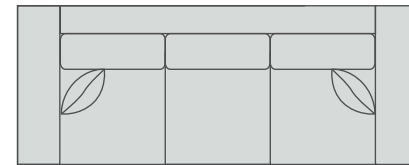

4365-S3 Astor Long Sofa
 100w 40d 34h
 Inside: 81w 24d 17h
 Standard With Two 20" Throw Pillows

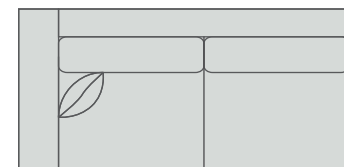

4365-JL Astor Left Arm Wide Loveseat
 83w 40d 34h
 Inside: 73½w 24d 17h
 Standard With One 20" Throw Pillow
 Married to 4365-KR

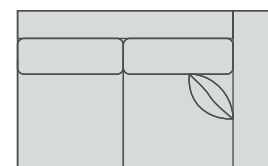

4365-LR Astor Right Arm Loveseat
 64w 40d 34h
 Inside: 54½w 24d 17h
 Standard With One 20" Throw Pillow

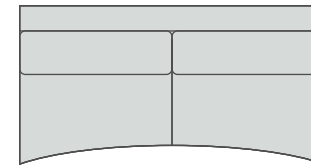

4365-S0 Astor Armless Shaped Sofa
 76½w 40d 34h
 Inside: 76½w 24d 17h



4365-A1 Astor Armless Chair
 28w 40d 34h
 Inside: 28w 24d 17h

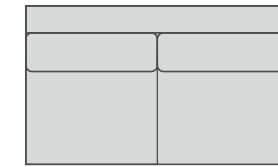

4365-L0 Astor Armless Standard Loveseat
 66w 40d 34h
 Inside: 66w 24d 17h

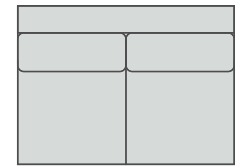

4365-B0 Astor Armless Short Loveseat
 56w 40d 34h
 Inside: 56w 24d 17h

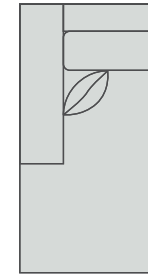

4365-CL Astor Left Arm Chaise
 36w 67½d 34h
 Inside: 26½w 51½d 17h
 Standard With One 20" Throw Pillow

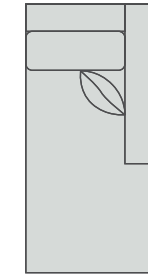

4365-CR Astor Right Arm Chaise
 36w 67½d 34h
 Inside: 26½w 51½d 17h
 Standard With One 20" Throw Pillow

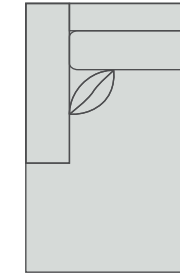

4365-KL Astor Left Arm Chaise
 45w 67½d 34h
 Inside: 35½w 51½d 17h
 Standard With One 20" Throw Pillow
 Married to 4365-JR

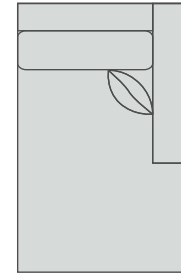

4365-KR Astor Right Arm Chaise
 45w 67½d 34h
 Inside: 35½w 51½d 17h
 Standard With One 20" Throw Pillow
 Married to 4365-JL



4365-CA Astor Armless Chaise
 32w 67½d 34h
 Inside: 32w 51½d 17h

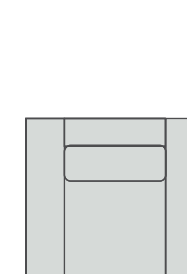

4365-C1 Astor Chair
 45w 40d 34h
 Inside: 26w 24d 17h

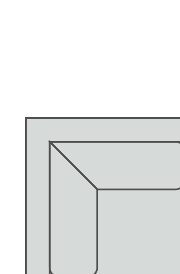

4365-E1 Astor Inside Corner
 40w 40d 34h
 Inside: 24w 24d 17h

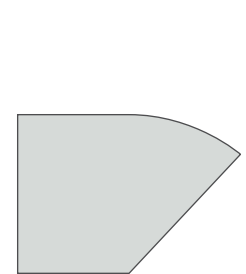

4365-BL Astor Left Bumper Ottoman
 56w 40d 17h



4365-L04 Astor Left Shaped Ottoman
 35w 50d 17h

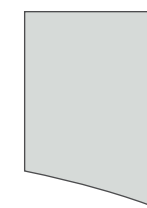

4365-R04 Astor Right Shaped Ottoman
 35w 50d 17h



4365-O1 Astor Ottoman
 40w 28d 17h



4365-O3 Astor Ottoman & 1/2
 50w 40d 17h

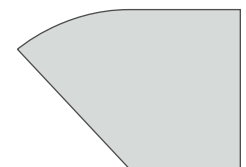

4365-BR Astor Right Bumper Ottoman
 56w 40d 17h

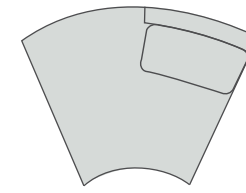

4366-CCL
Valerie Curved Chaise Left
62W 45D 34H
Inside: 52W 24D 17H

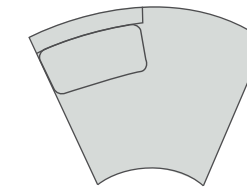

4366-CCR
Valerie Curved Chaise Right
62W 45D 34H
Inside: 52W 24D 17H

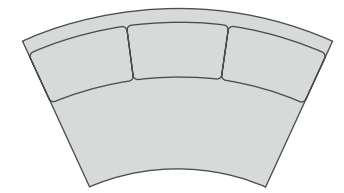

4366-CSO
Valerie Curved Armless Sofa
78W 45D 34H
Inside: 46W 24D 17H

4366-CSL
Valerie Curved Left Arm Sofa

85W 45D 34H
Inside: 75½W 24D 17H
Arm Height: 24 Seat Height: 17
Standard With One 20" Throw Pillow
Loose Pillow Back
Finish Shown: Walnut

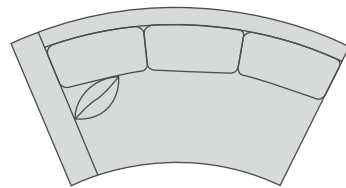

4366-CSL
Valerie Curved Left Arm Sofa
85W 45D 34H
Inside: 75½W 24D 17H
Standard With One 20" Throw Pillow

4366-CSR
Valerie Curved Right Arm Sofa

85W 45D 34H
Inside: 75½W 24D 17H
Arm Height: 24 Seat Height: 17
Standard With One 20" Throw Pillow
Loose Pillow Back
Finish Shown: Walnut

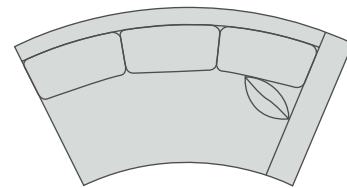

4366-CSR
Valerie Curved Right Arm Sofa
85W 45D 34H
Inside: 75½W 24D 17H
Standard With One 20" Throw Pillow

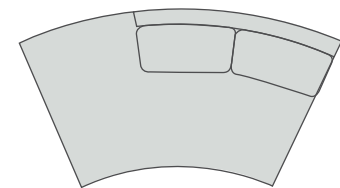

4366-CBL
Valerie Curved Left Arm Bumper
81W 45D 34H
Inside: 65W 24D 17H

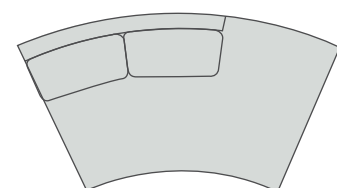

4366-CBR
Valerie Curved Right Arm Bumper
81W 45D 34H
Inside: 65W 24D 17H

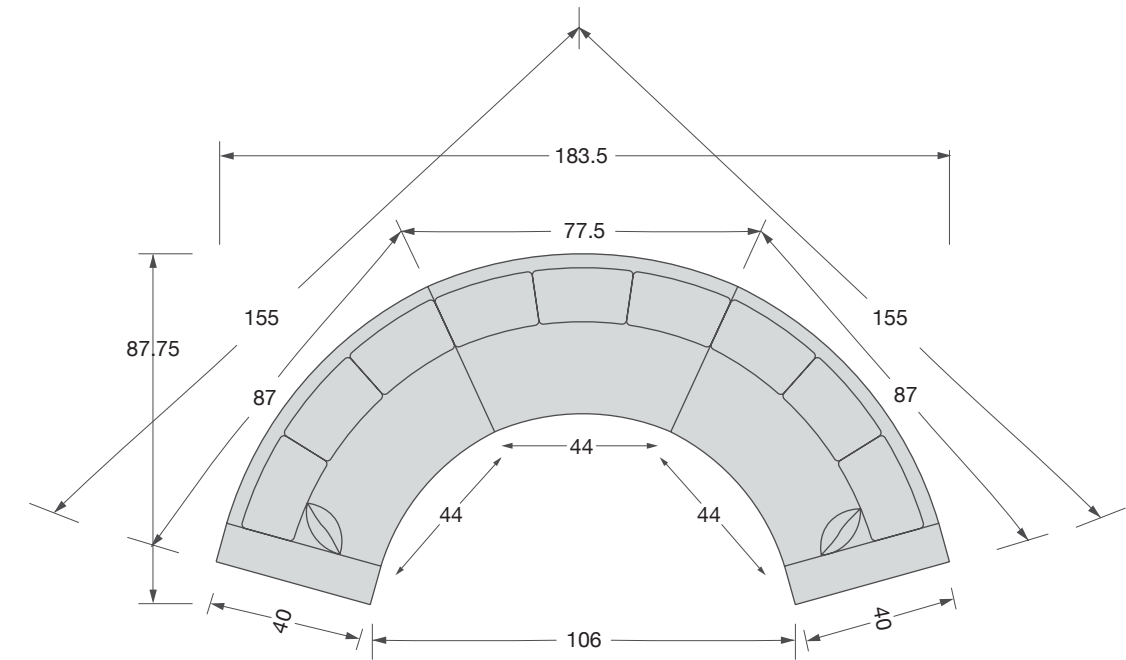

4366-CSL Valerie Curved Left Arm Sofa
4366-CSO Valerie Curved Armless Sofa
4366-CSR Valerie Curved Right Arm Sofa

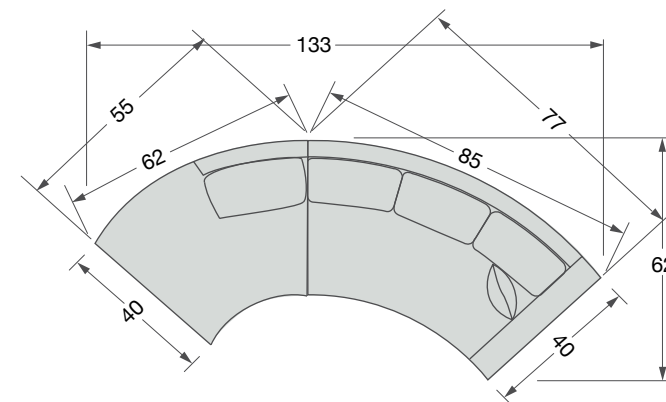

4366-CCL Valerie Curved Chaise Left
4366-CSR Valerie Curved Right Arm Sofa

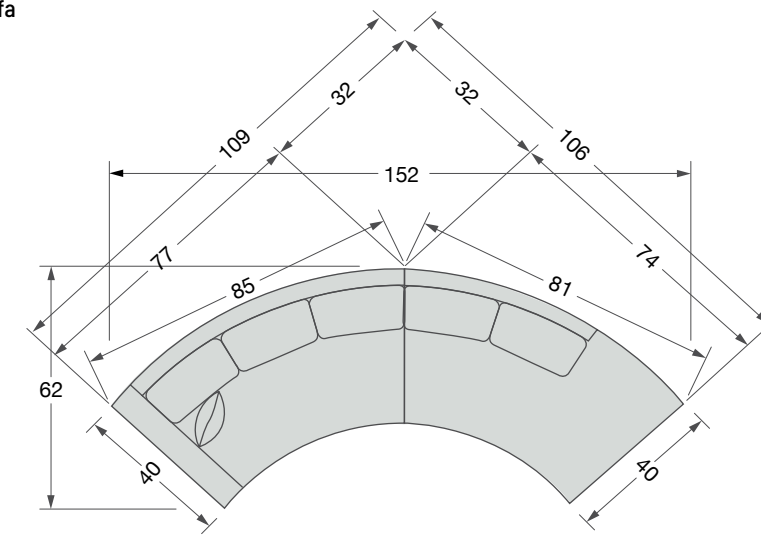

4366-CSL Valerie Curved Left Arm Sofa
4366-CBR Valerie Curved Right Arm Bumper



4367-SR
Melissa Right Arm Sofa

92W 40D 34H
Inside: 82½W 24D 17H
Arm Height: 24 Seat Height: 17
Loose Pillow Back
Standard With One 20" Throw Pillow
Finish Shown: Walnut

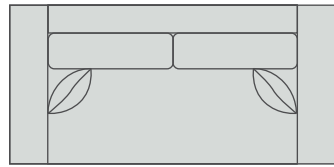

4367-S1
Melissa Short Sofa
82W 40D 34H
Inside: 63W 24D 17H
Standard With Two 20" Throw Pillows



4367-SL
Melissa Left Arm Sofa
92W 40D 34H
Inside: 82½W 24D 17H
Standard With One 20" Throw Pillow



4367-JR
Melissa Right Arm Wide Loveseat
83W 40D 34H
Inside: 73½W 24D 17H
Standard With One 20" Throw Pillow
Married to 4367-KL

4367-E1
Melissa Inside Corner

40W 40D 34H
Inside: 24W 24D 17H
Arm Height: 24 Seat Height: 17
Loose Pillow Back
Finish Shown: Walnut

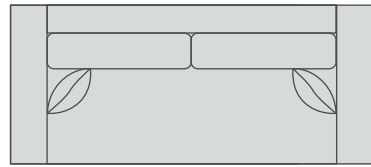

4367-S2
Melissa Standard Sofa
91W 40D 34H
Inside: 72W 24D 17H
Standard With Two 20" Throw Pillows



4367-SR
Melissa Right Arm Sofa
92W 40D 34H
Inside: 82½W 24D 17H
Standard With One 20" Throw Pillow

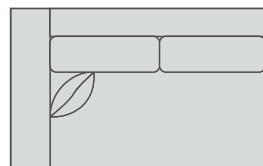

4367-LL
Melissa Left Arm Loveseat
64W 40D 34H
Inside: 54½W 24D 17H
Standard With One 20" Throw Pillow

4367-LL
Melissa Left Arm Loveseat

64W 40D 34H
Inside: 54½W 24D 17H
Arm Height: 24 Seat Height: 17
Loose Pillow Back
Standard With One 20" Throw Pillow
Finish Shown: Walnut

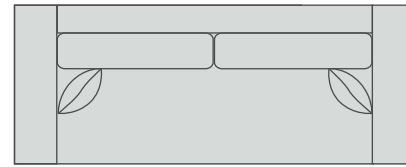

4367-S3
Melissa Long Sofa
100W 40D 34H
Inside: 81W 24D 17H
Standard With Two 20" Throw Pillows

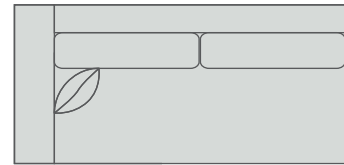

4367-JL
Melissa Left Arm Wide Loveseat
83W 40D 34H
Inside: 73½W 24D 17H
Standard With One 20" Throw Pillow
Married to 4367-KR

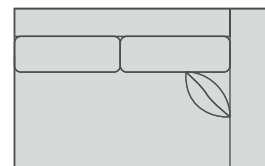

4367-LR
Melissa Right Arm Loveseat
64W 40D 34H
Inside: 54½W 24D 17H
Standard With One 20" Throw Pillow

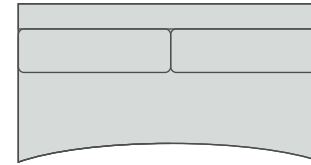

4367-S0
Melissa Armless Shaped Sofa
76½W 40D 34H
Inside: 76½W 24D 17H



4367-A1
Melissa Armless Chair
28W 40D 34H
Inside: 28W 24D 17H

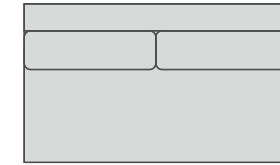

4367-L0
Melissa Armless Standard Loveseat
66W 40D 34H
Inside: 66W 24D 17H

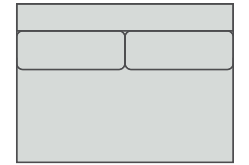

4367-B0
Melissa Armless Short Loveseat
56W 40D 34H
Inside: 56W 24D 17H

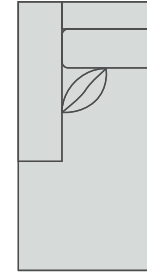

4367-CL
Melissa Left Arm Chaise
36W 67½D 34H
Inside: 26½W 51½D 17H
Standard With One 20" Throw Pillow

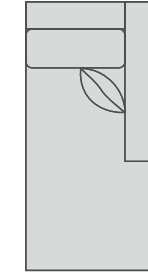

4367-CR
Melissa Right Arm Chaise
36W 67½D 34H
Inside: 26½W 51½D 17H
Standard With One 20" Throw Pillow

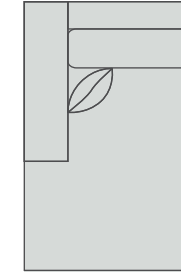

4367-KL
Melissa Left Arm Chaise
45W 67½D 34H
Inside: 35½W 51½D 17H
Standard With One 20" Throw Pillow
Married to 4367-JR

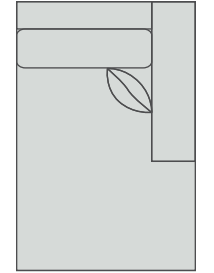

4367-KR
Melissa Right Arm Chaise
45W 67½D 34H
Inside: 35½W 51½D 17H
Standard With One 20" Throw Pillow
Married to 4367-JL



4367-CA
Melissa Armless Chaise
32W 67½D 34H
Inside: 32W 51½D 17H

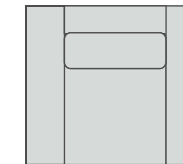

4367-C1
Melissa Chair
45W 40D 34H
Inside: 26W 24D 17H

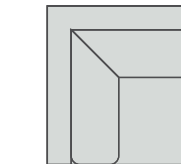

4367-E1
Melissa Inside Corner
40W 40D 34H
Inside: 24W 24D 17H

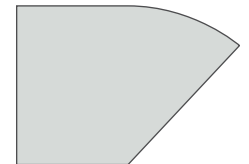

4367-BL
Melissa Left Bumper Ottoman
56W 40D 17H

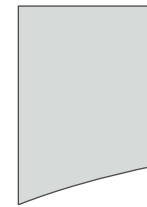

4367-L04
Melissa Left Shaped Ottoman
35W 50D 17H

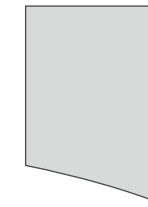

4367-R04
Melissa Right Shaped Ottoman
35W 50D 17H



4367-01
Melissa Ottoman
40W 28D 17H



4367-03
Melissa Ottoman & 1/2
50W 40D 17H

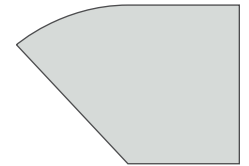

4367-BR
Melissa Right Bumper Ottoman
56W 40D 17H



4368-LL
Whitman Left Arm Loveseat

64W 40D 34H
Inside: 54½W 24D 17H
Arm Height: 24 Seat Height:17
Loose Pillow Back
Standard With One 20" Throw Pillow
Finish Shown: Walnut

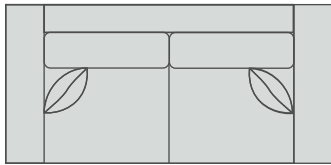

4368-S1
Whitman Short Sofa
82W 40D 34H
Inside: 63W 24D 17H
Standard With Two 20" Throw Pillows

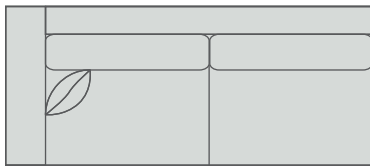

4368-SL
Whitman Left Arm Sofa
92W 40D 34H
Inside: 82½W 24D 17H
Standard With One 20" Throw Pillow



4368-JR
Whitman Right Arm Wide Loveseat
83W 40D 34H
Inside: 73½W 24D 17H
Standard With One 20" Throw Pillow
Married To 4368-KL

4368-E1
Whitman Inside Corner

40W 40D 34H
Inside: 24W 24D 17H
Seat Height:17
Loose Pillow Back
Finish Shown: Walnut

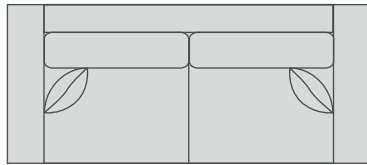

4368-S2
Whitman Standard Sofa
91W 40D 34H
Inside: 72W 24D 17H
Standard With Two 20" Throw Pillows

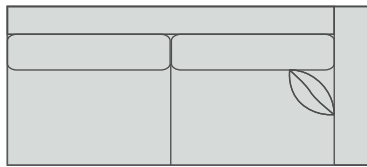

4368-SR
Whitman Right Arm Sofa
92W 40D 34H
Inside: 82½W 24D 17H
Standard With One 20" Throw Pillow

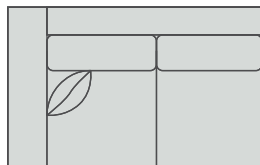

4368-LL
Whitman Left Arm Loveseat
64W 40D 34H
Inside: 54½W 24D 17H
Standard With One 20" Throw Pillow

4368-SR
Whitman Right Arm Sofa

92W 40D 34H
Inside: 82½W 24D 17H
Arm Height: 24 Seat Height:17
Loose Pillow Back
Standard With One 20" Throw Pillow
Finish Shown: Walnut

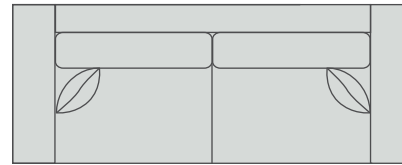

4368-S3
Whitman Long Sofa
100W 40D 34H
Inside: 81W 24D 17H
Standard With Two 20" Throw Pillows

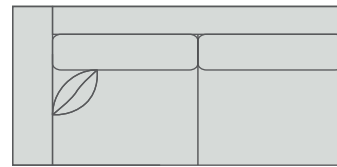

4368-JL
Whitman Left Arm Wide Loveseat
83W 40D 34H
Inside: 73½W 24D 17H
Standard With One 20" Throw Pillow
Married To 4368-KR

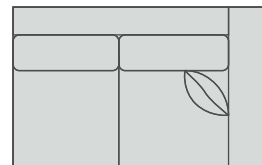

4368-LR
Whitman Right Arm Loveseat
64W 40D 34H
Inside: 54½W 24D 17H
Standard With One 20" Throw Pillow

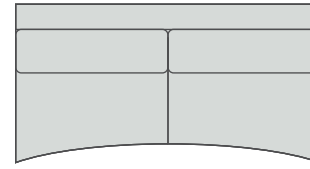

4368-S0
Whitman Shaped Armless Sofa
76½W 40D 34H
Inside: 76½W 24D 17H



4368-A1
Whitman Armless Chair
28W 40D 34H
Inside: 28W 24D 17H

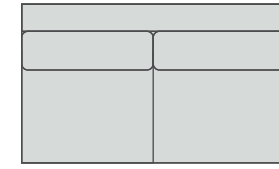

4368-L0
Whitman Armless Standard Loveseat
66W 40D 34H
Inside: 66W 24D 17H



4368-B0
Whitman Armless Short Loveseat
56W 40D 34H
Inside: 56W 24D 17H

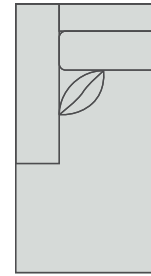

4368-CL
Whitman Left Arm Chaise
36W 67½D 34H
Inside: 26½W 51½D 17H
Standard With One 20" Throw Pillow

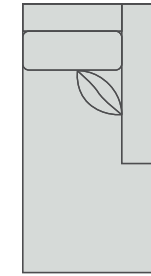

4368-CR
Whitman Right Arm Chaise
36W 67½D 34H
Inside: 26½W 51½D 17H
Standard With One 20" Throw Pillow

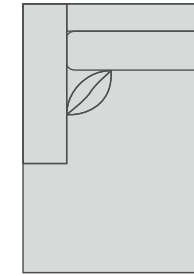

4368-KL
Whitman Left Arm Chaise
45W 67½D 34H
Inside: 35½W 51½D 17H
Standard With One 20" Throw Pillow
Married To 4368-JR

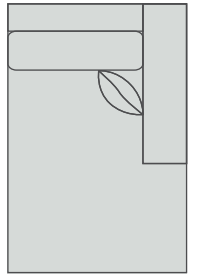

4368-KR
Whitman Right Arm Chaise
45W 67½D 34H
Inside: 35½W 51½D 17H
Standard With One 20" Throw Pillow
Married To 4368-JL



4368-CA
Whitman Armless Chaise
32W 67½D 34H
Inside: 32W 51½D 17H

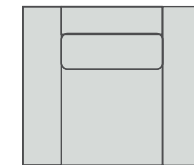

4368-C1
Whitman Chair
45W 40D 34H
Inside: 26W 24D 17H

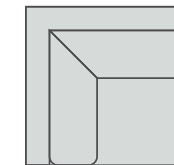

4368-E1
Whitman Inside Corner
40W 40D 34H
Inside: 24W 24D 17H

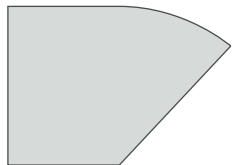

4368-BL
Whitman Left Bumper Ottoman
56W 40D 17H

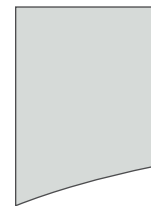

4368-L04
Whitman Left Shaped Ottoman
35W 50D 17H

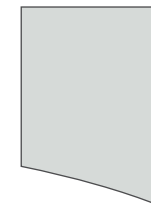

4368-R04
Whitman Right Shaped Ottoman
35W 50D 17H



4368-O1
Whitman Ottoman
40W 28D 17H



4368-O3
Whitman Ottoman & 1/2
50W 40D 17H

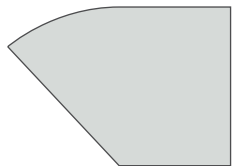

4368-BR
Whitman Right Bumper Ottoman
56W 40D 17H



4901-CL
Amy Left Arm Chaise

30w 65d 37h
Inside: 26½w 49d 19h
Arm Height: 24½ Seat Height: 18
Loose Pillow Back
Standard With One 20" Throw Pillow
Finish Shown: Walnut



4901-SR
Amy Right Arm Sofa

83w 39d 37h
Inside: 78½w 22d 19h
Arm Height: 24½ Seat Height: 18
Loose Pillow Back
Standard With One 20" Throw Pillow
Finish Shown: Walnut



4901-C3
Amy Swivel Chair

33½w 39d 37h
Inside: 26½w 22d 19h
Arm Height: 24½ Seat Height: 18
Loose Pillow Back

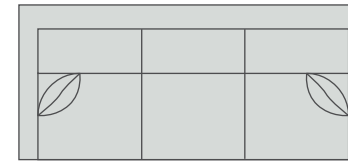

4901-S1
Amy Sofa
87½w 39d 37h
Inside: 78½w 22d 19h
Standard With Two 20" Throw Pillows

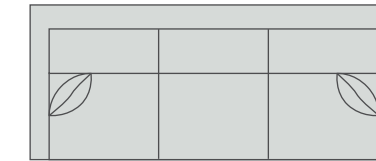

4901-S2
Amy Long Sofa
92½w 39d 37h
Inside: 84½w 22d 19h
Standard With Two 20" Throw Pillows

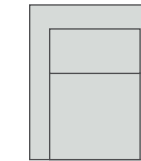

4901-C1
Amy Chair
33½w 39d 37h
Inside: 26½w 22d 19h

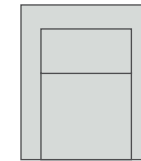

4901-C3
Amy Swivel Chair
33½w 39d 37h
Inside: 26½w 22d 19h

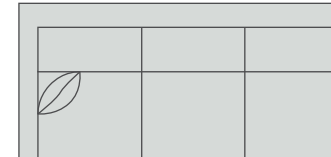

4901-SL
Amy Left Arm Sofa
83w 39d 37h
Inside: 78½w 22d 19h
Standard With One 20" Throw Pillow

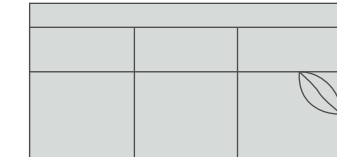

4901-SR
Amy Right Arm Sofa
83w 39d 37h
Inside: 78½w 22d 19h
Standard With One 20" Throw Pillow

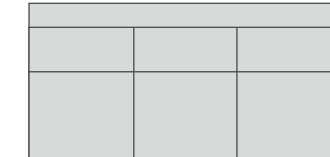

4901-SO
Amy Armless Sofa
78½w 39d 37h
Inside: 78½w 22d 19h

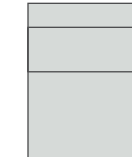

4901-A1
Amy Armless Chair
26½w 39d 37h
Inside: 26½w 22d 19h

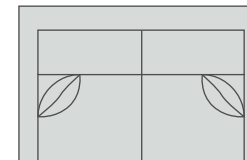

4901-L1
Amy Loveseat
61½w 39d 37h
Inside: 52½w 22d 19h
Standard With Two 20" Throw Pillows

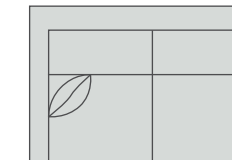

4901-LL
Amy Left Arm Loveseat
56½w 39d 37h
Inside: 52w 22d 19h
Standard With One 20" Throw Pillow

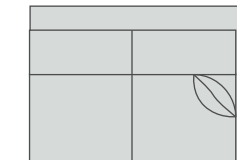

4901-LR
Amy Right Arm Loveseat
56½w 39d 37h
Inside: 52w 22d 19h
Standard With One 20" Throw Pillow

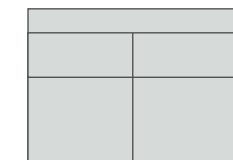

4901-L0
Amy Armless Loveseat
52½w 39d 37h
Inside: 52½w 22d 19h

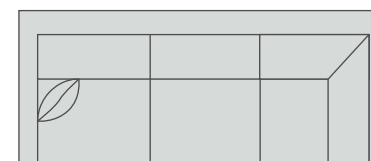

4901-DL
Amy Left Arm Corner Sofa
94w 39d 37h
Inside: 75w 22d 19h
Standard With One 20" Throw Pillow

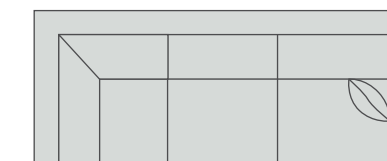

4901-DR
Amy Right Arm Corner Sofa
94w 39d 37h
Inside: 75w 22d 19h
Standard With One 20" Throw Pillow

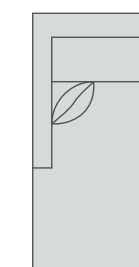

4901-CL
Amy Left Arm Chaise
30w 65d 37h
Inside: 26½w 49d 19h
Standard With One 20" Throw Pillow

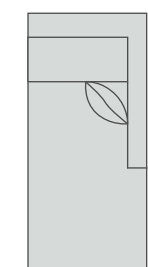

4901-CR
Amy Right Arm Chaise
30w 65d 37h
Inside: 26½w 49d 19h
Standard With One 20" Throw Pillow



4901-O1
Amy Ottoman
28w 23d 17h

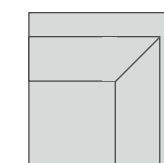

4901-E1
Amy Inside Corner
39w 39d 37h
Inside: 22w 22d 19h



4903-LL
Kendrick Left Arm Loveseat

58½W 36½D 37½H
Inside: 52W 22D 19½H
Arm Height: 24½ Seat Height: 18
Loose Pillow Back
Standard With One 20" Throw Pillow
Finish Shown: Walnut



4903-CR
Kendrick Right Arm Chaise

32½W 64½D 37½H
Inside: 26½W 48D 19½H
Arm Height: 24½ Seat Height: 18
Loose Pillow Back
Standard With One 20" Throw Pillow
Finish Shown: Walnut



4903-S1
Kendrick Sofa

90W 36½D 37½H
Inside: 78½W 22D 19½H
Arm Height: 24½ Seat Height: 18
Loose Pillow Back
Standard With Two 20" Throw Pillows
Finish Shown: Walnut

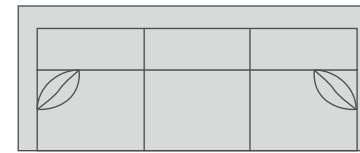

4903-S1
Kendrick Sofa
90W 36½D 37½H
Inside: 78½W 22D 19½H
Standard With Two 20" Throw Pillows

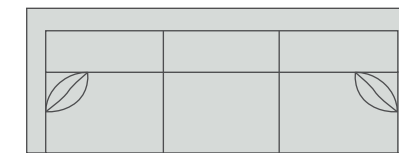

4903-S2
Kendrick Long Sofa
98W 36½D 37½H
Inside: 84½W 22D 19½H
Standard With Two 20" Throw Pillows

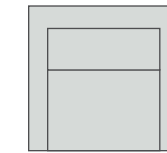

4903-C1
Kendrick Chair
38W 36½D H37½H
Inside: 26½W 22D 19½H

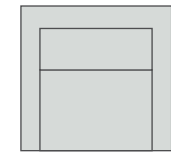

4903-C3
Kendrick Swivel Chair
38W 36½D 37½H
Inside: 26½W 22D 19½H

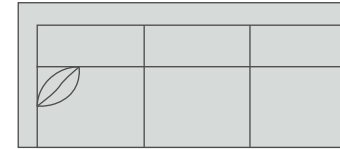

4903-SL
Kendrick Left Arm Sofa
84½W 36½D 37½H
Inside: 78½W 22D 19½H
Standard With One 20" Throw Pillow

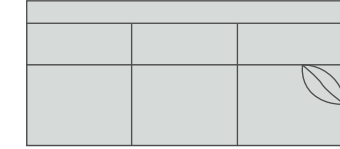

4903-SR
Kendrick Right Arm Sofa
84½W 36½D 37½H
Inside: 78½W 22D 19½H
Standard With One 20" Throw Pillow

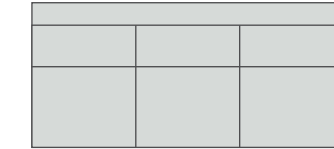

4903-S0
Kendrick Armless Sofa
78½W 36½D 37½H
Inside: 78½W 22D 19½H

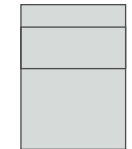

4903-A1
Kendrick Armless Chair
26½W 36½D 37½H
Inside: 26½W 22D 19½H

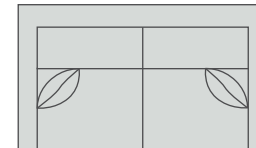

4903-L1
Kendrick Loveseat
63½W 36½D 37½H
Inside: 52W 22D 19½H
Standard With Two 20" Throw Pillows

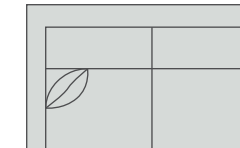

4903-LL
Kendrick Left Arm Loveseat
58½W 36½D 37½H
Inside: 52W 22D 19½H
Standard With One 20" Throw Pillow

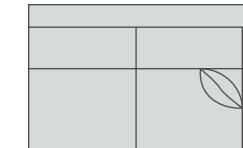

4903-LR
Kendrick Right Arm Loveseat
58½W 36½D 37½H
Inside: 52W 22D 19½H
Standard With One 20" Throw Pillow

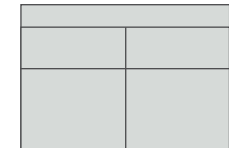

4903-L0
Kendrick Armless Loveseat
52½W 36½D 37½H
Inside: 52W 22D 19½H

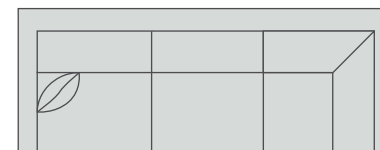

4903-DL
Kendrick Left Arm Corner Sofa
95½W 36½D 37½H
Inside: 75W 22D 19½H
Standard With One 20" Throw Pillow

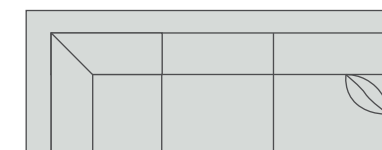

4903-DR
Kendrick Right Arm Corner Sofa
95½W 36½D 37½H
Inside: 75W 22D 19½H
Standard With One 20" Throw Pillow

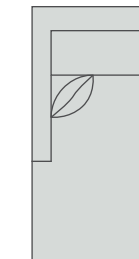

4903-CL
Kendrick Left Arm Chaise
32½W 64D 37½H
Inside: 26½W 48D 19½H
Standard With One 20" Throw Pillow

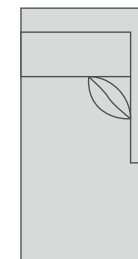

4903-CR
Kendrick Right Arm Chaise
32½W 64D 37½H
Inside: 26½W 48D 19½H
Standard With One 20" Throw Pillow



4903-O1
Kendrick Ottoman
28W 23D 17H

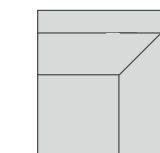

4903-E1
Kendrick Inside Corner
36½W 36½D 37½H
Inside: 22W 22D 19½H

5108-01 Adeline Ottoman
 5108-E1 Adeline Corner Chair
 5108-A1 Adeline Armless Chair
 5108-E1 Adeline Corner Chair
 3439-02 Louise Caster Ottoman
 SER-006D Mado Waterfall Etagere



**5108-E1
 Adeline
 Corner Chair**

39½w 39½D 33½H
 Inside: 24w 24D 17½H
 Arm Height: 33½ Seat Height: 16
 Loose Pillow Back



**5108-A1
 Adeline
 Armless Chair**

36w 39½D 33½H
 Inside: 36w 24D 17½H
 Seat Height: 16
 Loose Pillow Back



**5108-E1
 Adeline
 Corner Chair**

39½w 39½D 33½H
 Inside: 24w 24D 17½H
 Arm Height: 33½ Seat Height: 16
 Loose Pillow Back



**5108-01
 Adeline Ottoman**

39½w 39½D 16H
 Seat Height: 16

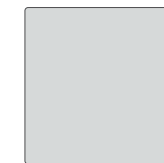

**5108-01
 Adeline Ottoman**
 39½w 39½D 16H

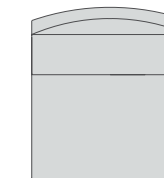

**5108-A1
 Adeline Armless Chair**
 36w 39½D 33½H
 Inside: 36w 24D 17½H

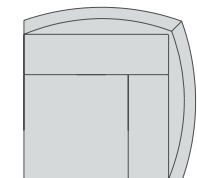

**5108-E1
 Adeline Corner Chair**
 39½w 39½D 33½H
 Inside: 24w 24D 17½H



DESIGN YOUR OWN

Create your own one-of-a-kind design statement with Studio P. Each custom program is developed by Precedent with you in mind. Our programs offer thousands of custom options and are backed by time-tested engineering and manufacturing processes.

- Nocturne..... 173
- Luxe Life..... 175
- A La Carte..... 181
- Urban Planning..... 183
- Counter Proposal..... 189
- Classic Suite Retreat..... 191
- Luxury Suite Retreat..... 197
- Modern Intuition..... 203
- Signature Sides..... 209

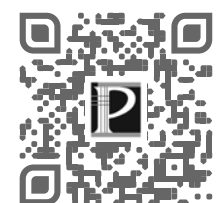

NOCTURNE

CUSTOM PROGRAM

It's easy to order your own upholstered bed or headboard.
Just follow this illustration and fill in each circle with your selections.

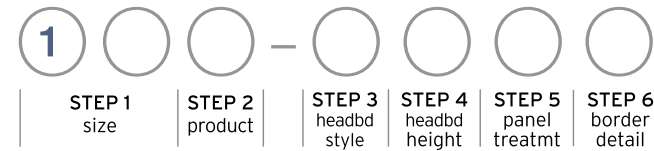

When selecting a leather bed or headboard, begin the style number with the prefix L.



1. Choose Your Size

- T Twin 45w
 L Twin Extra-Long 45w
 F Full 60w
 Q Queen 66w
 K King 82w
 C California King 78w

2. Choose Your Product

- H Headboard Only
 Headboard attaches to standard metal bed frame (not included).
- B Bed
 Bed = Headboard/Foot Rail/Side Rails/Wood Slats. Bed requires box spring.
- P Platform Bed
 Platform Bed = Headboard/Foot Rail/Side Rails/Bunkie Boards. Engineered to accept a mattress only.
- S Storage Bed With Platform
 Storage Bed = Headboard/Foot Rail/Side Rails/Bunkie Boards/Storage Drawer. Engineered to accept a mattress only.

3. Choose Your Headboard Style



- A Arc
 B Rounded Corner
 C Clipped Corner
 D Square
 E Camel
 G Ornate

4. Choose Your Headboard Height

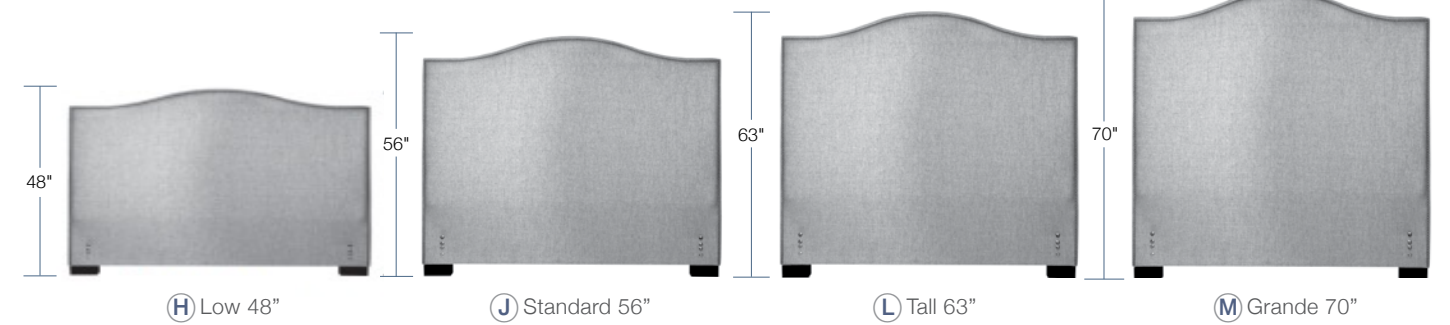

5. Choose Your Panel Treatment*

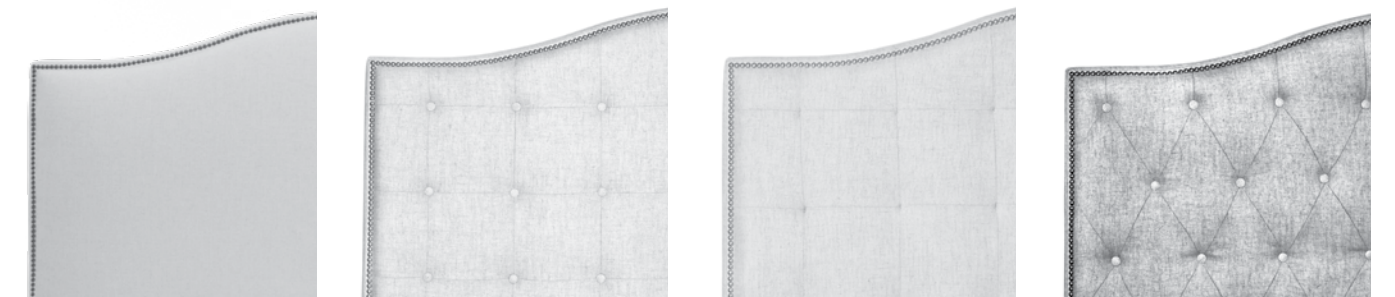

- N Plain
 O Square Button Tufted
 I Square Buttonless Tufted
 R Diamond Button Tufted



- Q Vertical Channel
 P Horizontal Channel
 S Mega Square Buttonless Tuft

6. Choose Your Border Detail**

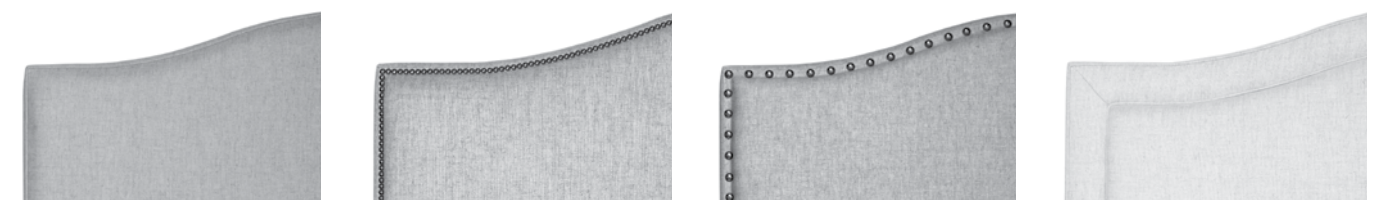

- U Borderless
 V Borderless/#1 Small Nail
 Y Borderless/#3 Large Nail
 W Border Welt Edge/Welt Inside

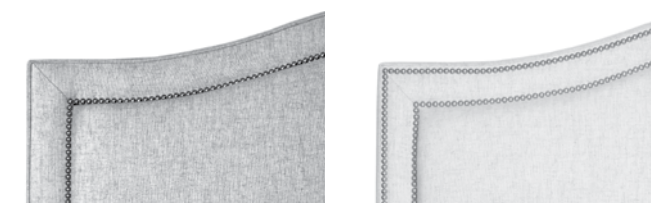

- X Border Welt Edge/#1 Small Nail inside
 Z Border Welt Edge/#1 Small Nail inside

* When choosing the N-Plain Panel Treatment for fabric Headboards or Beds, please be aware that all non-railrooded fabrics will be applied using two vertical seams in the headboard. Please refer to the Fabric List, which can be found by visiting precedent-furniture.com or sherrilldealers.com, to determine whether your fabric selection is non-railrooded. When choosing the N-Plain Panel Treatment for leather Headboards or Beds, please be aware that the leather will be applied using vertical seams in the headboard. For options V, X, or Z, please specify small #1 nailhead. For option Y, please specify large #3 nailhead. Standard Walnut Finish. Optional Finish Cinder, Desert, Ebony, Ember, Fawn, French Oak, Fruitwood, Kahlua, Smoked, Soho and Sugar. For Nail Finish options, visit precedent-furniture.com, sherrilldealers.com, or see Page 215.

3479-C3 Halsey Swivel Chair
3SL-TBUS Luxe Life Luxury Left Arm Sofa
3E1-XBUS Luxe Life Luxury Inside Corner
3SR-TBUS Luxe Life Luxury Right Arm Sofa



LUXE LIFE

CUSTOM PROGRAM

IT'S EASY TO ORDER YOUR OWN UPHOLSTERED SEATING.

Just follow this illustration and fill in each circle with your selection. Repeat for each component.



2 Series = 39" depth | 3 Series = 43" depth

1. Choose Your Depth

Choose a series number to indicate the depth of your components.

CLASSIC 2 SERIES - 39" DEPTH



- Depth : 39"
- Height : 34"
- Seat Height : 18"
- Arm Height : 25"
- Inside Seat Depth : 22"

LUXURY 3 SERIES - 43" DEPTH



- Depth : 43"
- Height : 36"
- Seat Height : 18"
- Arm Height : 25"
- Inside Seat Depth : 26"

2. Choose Your Components

CLASSIC DEPTH COMPONENTS

Seat Height: 18" | Arm Height: 25"

*Dimensions listed are for Shaped Track arm option. For Flare arm dimension, add .5" for each arm on piece. For Small Roll arm dimension, add 1.5" for each arm on piece.

 2 Seat Sofa 2 S 1 - ○ ○ ○ ○ ○ ○ W86 D39 H34 Inside Seat W76 D22 H16 Standard With Two 20" Throw Pillows	 3 Seat Sofa 2 S 2 - ○ ○ ○ ○ ○ ○ W100 D39 H34 Inside Seat W90 D22 H16 Standard With Two 20" Throw Pillows	 Chair & Half 2 C H - ○ ○ ○ ○ ○ ○ W43 D39 H34 Inside Seat W33 D22 H16	 Chair 2 C 1 - ○ ○ ○ ○ ○ ○ W35 D39 H34 Inside Seat W25 D22 H16	
 Left Arm Sofa 2 S L - ○ ○ ○ ○ ○ ○ W82 D39 H34 Inside Seat W76 D22 H16 Standard With One 20" Throw Pillow	 Right Arm Sofa 2 S R - ○ ○ ○ ○ ○ ○ W82 D39 H34 Inside Seat W76 D22 H16 Standard With One 20" Throw Pillow	 Armless Sofa 2 S O - X ○ ○ ○ ○ ○ ○ W76 D39 H34 Inside Seat W76 D22 H16	 Armless Chair 2 A 2 - X ○ ○ ○ ○ ○ ○ W38 D39 H34 Inside Seat W38 D22 H16	
 Left Arm Loveseat 2 L L - ○ ○ ○ ○ ○ ○ W65.5 D39 H34 Inside Seat W60 D22 H16 Standard With One 20" Throw Pillow	 Right Arm Loveseat 2 L R - ○ ○ ○ ○ ○ ○ W65.5 D39 H34 Inside Seat W60 D22 H16 Standard With One 20" Throw Pillow	 Armless Loveseat 2 L O - X ○ ○ ○ ○ ○ ○ W60 D39 H34 Inside Seat W60 D22 H16	 Armless Chair 2 A 1 - X ○ ○ ○ ○ ○ ○ W30 D39 H34 Inside Seat W30 D22 H16	
 Left Arm Chaise 2 C L - ○ ○ ○ ○ ○ ○ W44 D67 H34 Inside Seat W38 D50 H16 Standard With One 20" Throw Pillow	 Right Arm Chaise 2 C R - ○ ○ ○ ○ ○ ○ W44 D67 H34 Inside Seat W38 D50 H16 Standard With One 20" Throw Pillow	 Inside Corner 2 E 1 - X ○ ○ ○ ○ ○ ○ W39 D39 H34 Inside Seat W22 D22 H16 Standard With One 20" Throw Pillow	 Ottoman & Half 2 O H - X X ○ ○ ○ ○ ○ ○ W38 D26 H17	 Ottoman 2 O 1 - X X ○ ○ ○ ○ ○ ○ W26 D23 H17

LUXURY DEPTH COMPONENTS

Seat Height: 18" | Arm Height: 25"

*Dimensions listed are for Shaped Track arm option. For Flare arm dimension, add .5" for each arm on piece.
For Small Roll arm dimension, add 1.5" for each arm on piece.

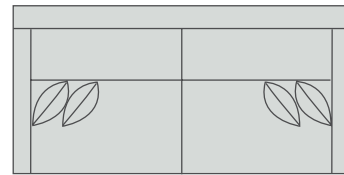

2 Seat Sofa

3 S 1 - ○ ○ ○ ○ ○

W86 D43 H36
Inside Seat W76 D26 H18
Standard With Four 20" Throw Pillows

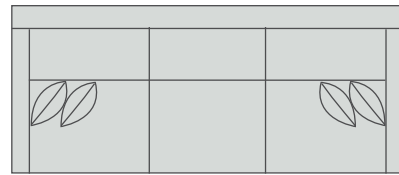

3 Seat Sofa

3 S 2 - ○ ○ ○ ○ ○

W100 D43 H36
Inside Seat W90 D26 H18
Standard With Four 20" Throw Pillows

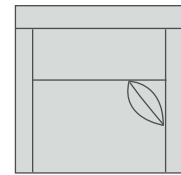

Chair & Half

3 C H - ○ ○ ○ ○ ○

W43 D43 H36
Inside Seat W33 D26 H18
Standard With One
20" Throw Pillow

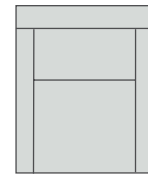

Chair

3 C 1 - ○ ○ ○ ○ ○

W35 D43 H36
Inside Seat W25 D26 H18

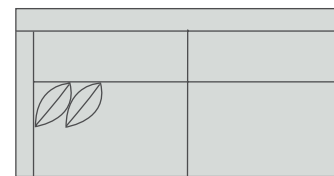

Left Arm Sofa

3 S L - ○ ○ ○ ○ ○

W82 D43 H36
Inside Seat W76 D26 H18
Standard With Two 20" Throw Pillows

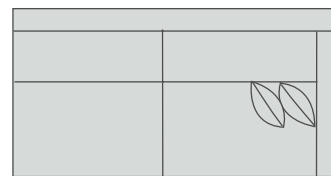

Right Arm Sofa

3 S R - ○ ○ ○ ○ ○

W82 D43 H36
Inside Seat W76 D26 H18
Standard With Two 20" Throw Pillows

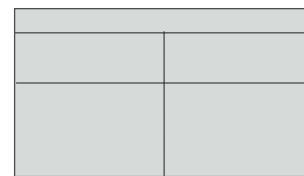

Armless Sofa

3 S O - X ○ ○ ○ ○

W76 D43 H36
Inside Seat W76 D26 H18



Armless Chair

3 A 2 - X ○ ○ ○ ○

W38 D43 H36
Inside Seat W38 D26 H18

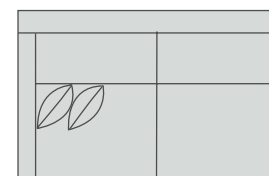

Left Arm Loveseat

3 L L - ○ ○ ○ ○ ○

W65.5 D43 H36
Inside Seat W60 D26 H18
Standard With Two 20" Throw Pillows

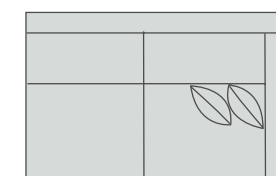

Right Arm Loveseat

3 L R - ○ ○ ○ ○ ○

W65.5 D43 H36
Inside Seat W60 D26 H18
Standard With Two 20" Throw Pillows

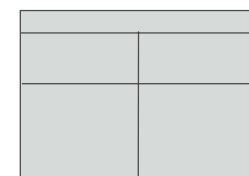

Armless Loveseat

3 L O - X ○ ○ ○ ○

W60 D43 H36
Inside Seat W60 D26 H18

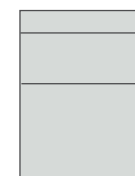

Armless Chair

3 A 1 - X ○ ○ ○ ○

W30 D43 H36
Inside Seat W30 D26 H18

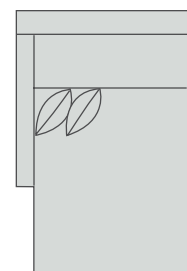

Left Arm Chaise

3 C L - ○ ○ ○ ○ ○

W44 D67 H36
Inside Seat W38 D50 H18
Standard With Two
20" Throw Pillows

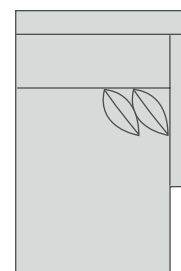

Right Arm Chaise

3 C R - ○ ○ ○ ○ ○

W44 D67 H36
Inside Seat W38 D50 H18
Standard With Two
20" Throw Pillows

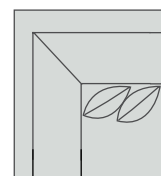

Inside Corner

3 E 1 - X ○ ○ ○ ○

W43 D43 H36
Inside Seat W26 D26 H18
Standard With Two
20" Throw Pillows



Ottoman & Half

3 O H - X X ○ ○ ○

W38 D26 H17



Ottoman

3 O 1 - X X ○ ○ ○

W26 D23 H17

3. Choose Your Arm Style ○ ○ ○ - ○ ○ ○ ○ ○



T Shaped Track



R Small Roll



F Flare

4. Choose Your Back Style ○ ○ ○ - ○ ○ ○ ○ ○



B Boxed



K Knife Edge

5. Choose Your Tailoring ○ ○ ○ - ○ ○ ○ ○ ○



W Weltd



U Unweltd

6. Choose Your Base Style ○ ○ ○ - ○ ○ ○ ○ ○



S Square



V Cone



Y Cylinder

Standard Walnut Finish. Optional Finish Cinder, Desert, Ebony, Ember, Fawn, French Oak, Fruitwood, Kahlua, Soho, Smoked, and Sugar.

Optional #1 Small Nailhead or #3 Large Nailhead. Available at an upcharge. Reference Precedent Price list for details.

A LA CARTE

CUSTOM PROGRAM

IT'S EASY TO ORDER YOUR OWN UPHOLSTERED DINING CHAIRS.

Just follow this illustration and fill in each circle with your selection.

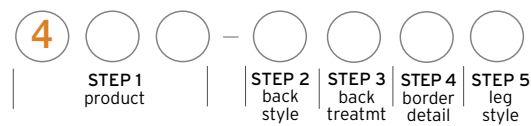

When selecting a leather Dining Chair, begin the style number with the prefix L.



1. Choose Your Product 4 (filled) (filled) (filled) - (empty) (empty) (empty) (empty)



4 D 1 Chair

W22
Inside Seat: W22 D18 H21



4 B Q Banquette

W51
Inside Seat W51 D18 H21

Seat Height = 19"

2. Choose Your Back Style 4 (empty) (empty) (filled) (empty) (empty) (empty)



G Greek



D Square



E Camel

3. Choose Your Back Treatment 4 (empty) (empty) (empty) - (filled) (empty) (empty) (empty)

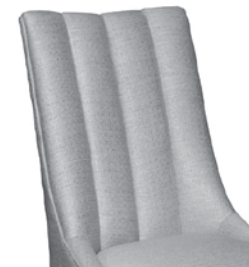

Q Channel



O Button Tufted



N Plain



P Buttonless Tufted

4. Choose Your Border Detail 4 (empty) (empty) (empty) - (empty) (empty) (filled) (empty)



W Welt Edge

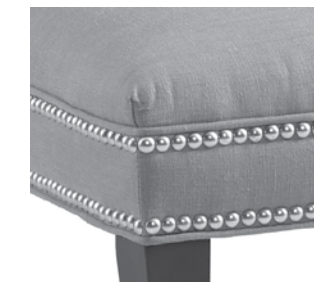

X Nailhead Trim

For Nail options specify Small #1 or Large #3 Nailhead. Optional #3 nailhead available as a spaced single-row base trim. Finishes: Antique, Antique Black, Bright Brass, Bronze, French Natural, Gold, Gun Metal, Black Nickel, Old Brass, Oxford, Platinum, Polished Nickel and Vintage. Finish must be specified on the order. For Nail Finish options, visit precedent-furniture.com, sherrilldealers.com, or see Page 215.

5. Choose Your Leg Style 4 (empty) (empty) (empty) - (empty) (empty) (empty) (filled)



U Flared



S Cabriole



T Straight Tapered

Standard Walnut Finish. Optional Finish Cinder, Desert, Ebony, Ember, Fawn, French Oak, Fruitwood, Kahlua, Smoked, Soho and Sugar.

5JL-POUZ Urban Planning Left Arm Wide Loveseat
5KR-POUZ Urban Planning Right Arm Chaise
3503-C3 Edward Swivel Chair
975-121 Malcom Cocktail Table
975-119 Malcom End Table



URBAN PLANNING

CUSTOM PROGRAM

5SL-DOWZ Urban Planning Left Arm Sofa
 5CR-DOWZ Urban Planning Right Arm Chaise
 2090-02 Elliot Caster Ottoman

IT'S EASY TO ORDER YOUR OWN UPHOLSTERED SEATING.

Just follow this illustration and fill in each circle with your selection. Repeat for each component.

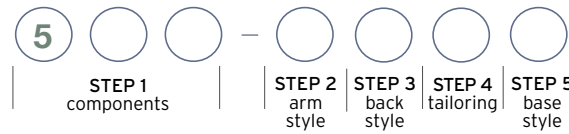

When selecting a leather component, begin the style number with the prefix L.



1. Choose Your Components 5 ○ ○ ○ - ○ ○ ○ ○ ○

2. Choose Your Arm Style 5 ○ ○ ○ - ○ ○ ○ ○ ○

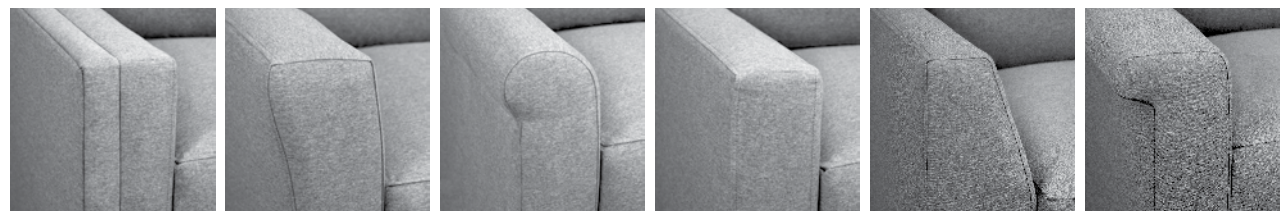

D Dual Track Arm F Flare Arm R Roll Arm T Track Arm P Wedge Q Ledge

3. Choose Your Back Style 5 ○ ○ ○ - ○ ○ ○ ○ ○

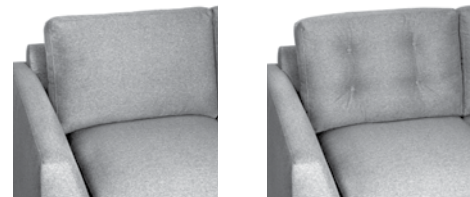

O Plain V Button Tufted

4. Choose Your Tailoring 5 ○ ○ ○ - ○ ○ ○ ○ ○



U Unwelted W Welted

5. Choose Your Base Style 5 ○ ○ ○ - ○ ○ ○ ○ ○



Z Wood Base A Angled Leg C Cylinder Leg M Metal Round N Metal Square

Z - Wood Base, A - Angled Leg and C - Cylinder legs are standard Walnut finish. Optional finishes Cinder, Desert, Ebony, Ember, Fawn, French Oak, Fruitwood, Kahlua, Smoked, Soho and Sugar. Available at no charge. M - Metal Round & N - Metal Square, no optional finishes available.

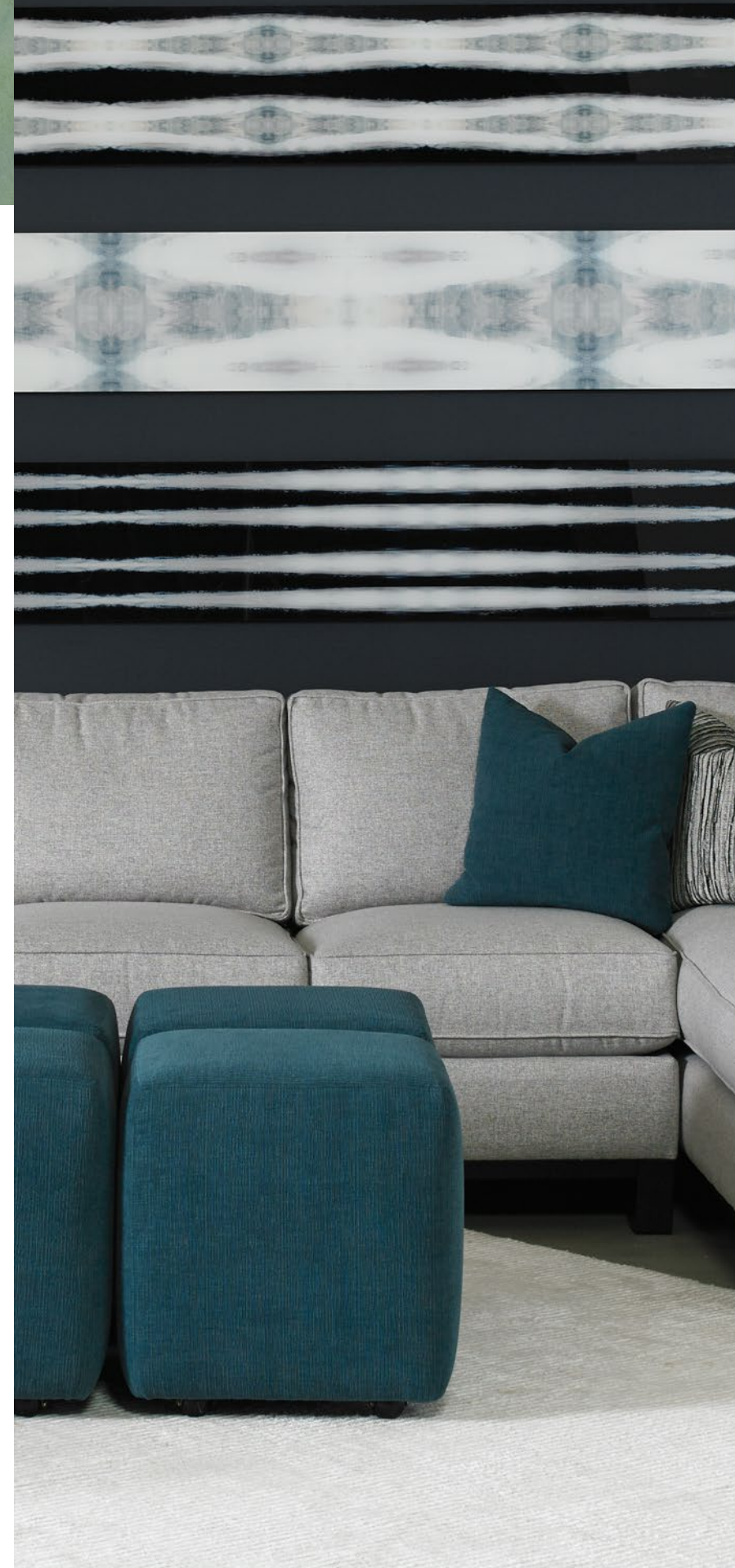

URBAN PLANNING | CUSTOM PROGRAM

URBAN PLANNING COMPONENTS

Seat Height: 18" | Arm Height: 24"

*Dimensions listed are for Dual Track, Flare and Track Arm option. For Roll and Wedge Arm dimensions, add 1" for each arm or piece. For Ledge Arm dimensions, add 2" for each arm or piece.

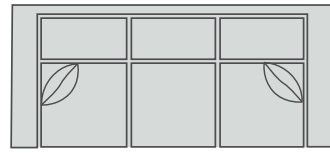

Sofa
 5 S 1 - ○ ○ ○ ○ ○
 W85 D37 H35
 Inside Seat: W75 D23 H17
 Standard With Two 20" Throw Pillows



Sofa
 5 S 3 - ○ ○ ○ ○ ○
 W85 D37 H35
 Inside Seat: W75 D23 H17
 Standard With Two 20" Throw Pillows

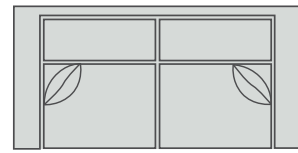

Sofa
 5 B 1 - ○ ○ ○ ○ ○
 W80 D37 H35
 Inside Seat: W70 D23 H17
 Standard With Two 20" Throw Pillows

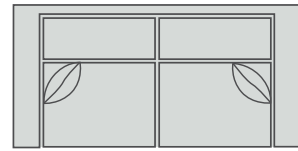

Love Seat
 5 L 2 - ○ ○ ○ ○ ○
 W72 D37 H35
 Inside Seat: W62 D23 H17
 Standard With Two 20" Throw Pillows

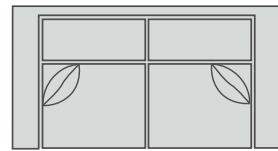

Love Seat
 5 L 1 - ○ ○ ○ ○ ○
 W60 D37 H35
 Inside Seat: W50 D23 H17
 Standard With Two 20" Throw Pillows

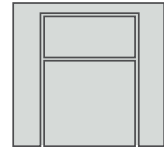

Chair
 5 C 1 - ○ ○ ○ ○ ○
 W35 D37 H35
 Inside Seat: W25 D23 H17

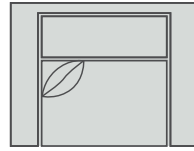

Chair & Half
 5 C H - ○ ○ ○ ○ ○
 W45 D37 H35
 Inside Seat: W35 D23 H17
 Standard With One 20" Throw Pillow

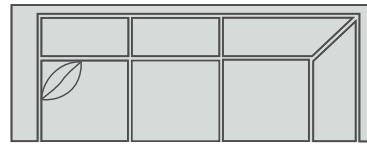

Left Arm Corner Sofa
 5 D L - ○ ○ ○ ○ ○
 W92 D37 H35
 Inside Seat: W77 D23 H17
 Standard With One 20" Throw Pillow

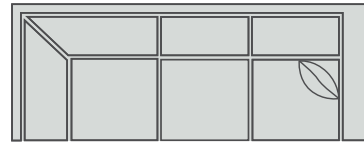

Right Arm Corner Sofa
 5 D R - ○ ○ ○ ○ ○
 W92 D37 H35
 Inside Seat: W77 D23 H17
 Standard With One 20" Throw Pillow

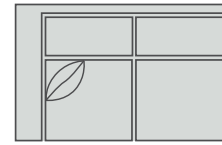

Left Arm Love Seat
 5 L L - ○ ○ ○ ○ ○
 W56 D37 H35
 Inside Seat: W50 D23 H17
 Standard With One 20" Throw Pillow

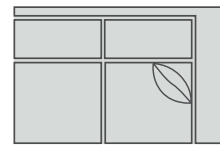

Right Arm Love Seat
 5 L R - ○ ○ ○ ○ ○
 W56 D37 H35
 Inside Seat: W50 D23 H17
 Standard With One 20" Throw Pillow

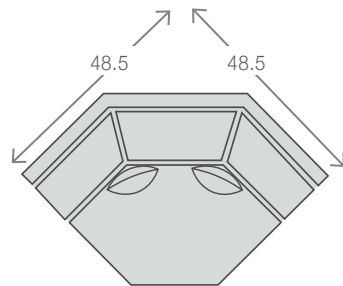

Wedge
 5 C U - X ○ ○ ○ ○
 W69 D45 H35
 Standard With Two 20" Throw Pillows

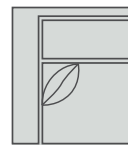

Left Arm Chair
 5 E L - ○ ○ ○ ○ ○
 W31 D37 H35
 Inside Seat: W26 D23 H17
 Standard With One 20" Throw Pillow

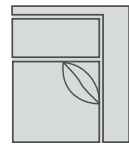

Right Arm Chair
 5 E R - ○ ○ ○ ○ ○
 W31 D37 H35
 Inside Seat: W26 D23 H17
 Standard With One 20" Throw Pillow

URBAN PLANNING COMPONENTS

Seat Height: 18" | Arm Height: 24"

*Dimensions listed are for Dual Track, Flare and Track Arm option. For Roll and Wedge Arm dimensions, add 1" for each arm or piece. For Ledge Arm dimensions, add 2" for each arm or piece.



Left Arm Sofa
 5 S L - ○ ○ ○ ○ ○
 W80 D37 H35
 Inside Seat: W75 D23 H17
 Standard With One 20" Throw Pillow



Right Arm Sofa
 5 S R - ○ ○ ○ ○ ○
 W80 D37 H35
 Inside Seat: W75 D23 H17
 Standard With One 20" Throw Pillow

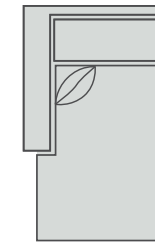

Left Arm Chaise
 5 C L - ○ ○ ○ ○ ○
 W35.5 D68 H35
 Inside Seat: W30 D54 H17
 Standard With One 20" Throw Pillow

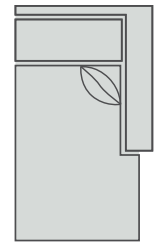

Right Arm Chaise
 5 C R - ○ ○ ○ ○ ○
 W35.5 D68 H35
 Inside Seat: W30 D54 H17
 Standard With One 20" Throw Pillow

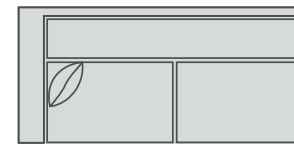

Left Arm Wide Love Seat
 5 J L - ○ ○ ○ ○ ○
 W80 D37 H35
 Inside Seat: W75 D23 H17
 Standard With One 20" Throw Pillow
 Married to 5KR-



Right Arm Wide Love Seat
 5 J R - ○ ○ ○ ○ ○
 W80 D37 H35
 Inside Seat: W75 D23 H17
 Standard With One 20" Throw Pillow
 Married to 5KL-

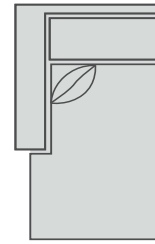

Left Arm Chaise
 5 K L - ○ ○ ○ ○ ○
 W44 D68 H35
 Inside Seat: W39 D54 H17
 Standard With One 20" Throw Pillow
 Married to 5JR-

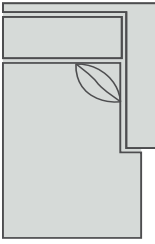

Right Arm Chaise
 5 K R - ○ ○ ○ ○ ○
 W44 D68 H35
 Inside Seat: W39 D54 H17
 Standard With One 20" Throw Pillow
 Married to 5JL-



Armless Sofa
 5 S O - X ○ ○ ○ ○
 W76 D37 H35
 Inside Seat: W76 D37 H17



Armless Love Seat
 5 L O - X ○ ○ ○ ○
 W55 D37 H35
 Inside Seat: W55 D37 H17



Armless Chair
 5 A 1 - X ○ ○ ○ ○
 W28 D37 H35
 Inside Seat: W28 D37 H17

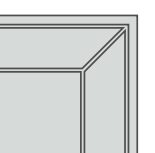

Inside Corner Chair
 5 E 1 - X ○ ○ ○ ○
 W37 D37 H35
 Inside Seat: W37 D37 H17

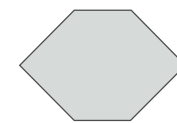

Shaped Ottoman
 5 O 4 - X X ○ ○ ○
 W52.5 D37 H18



Ottoman
 5 O 1 - X X ○ ○ ○
 W25 D17 H18



Ottoman & Half
 5 O H - X X ○ ○ ○
 W35 D24 H18

COUNTER PROPOSAL

CUSTOM PROGRAM

IT'S EASY TO ORDER YOUR OWN UPHOLSTERED STOOLS.

Just follow this illustration and fill in each circle with your selections.



When selecting a leather Stool, begin the style number with the prefix L.



1. Choose Your Product 6●●●-○○○○○



6 B S Bar Stool
W20" H46"
Inside Seat W20" D18"



6 C S Counter Stool
W20" H41"
Inside Seat W20" D18"

Bar Stool Seat Height = 29"
Counter Stool Seat Height = 24"

2. Choose Your Back Style 6○○-●○○○○



A Scoop



B Shield



C Square

3. Choose Your Back Treatment 6○○-○○○○○



Q Channel



O Button Tufted



N Plain



P Buttonless Tufted

4. Choose Your Border Detail 6○○-○○○○○



W Welt Edge



X Nailhead Trim

For Nail options specify Small #1 or Large #3 Nailhead. Optional #3 nailhead available as a spaced single-row base trim.

Finishes: Antique, Antique Black, Bright Brass, Bronze, French Natural, Gold, Gun Metal, Black Nickel, Old Brass, Oxford, Platinum, Polished Nickel and Vintage.

Finish must be specified on the order. For Nail Finish options, visit precedent-furniture.com, sherrilldealers.com, or see Page 215.

5. Choose Your Base Style 6○○-○○○○○



U Stationary Flared Leg



S Stationary Cabriole Leg



T Stationary Straight Tapered Leg



V Swivel Base

Standard Walnut Finish. Optional Finish Cinder, Desert, Ebony, Ember, Fawn, French Oak, Fruitwood, Kahlua, Smoked, Soho and Sugar.

Standard with Metal Kickplate. Please specify French Natural or Platinum finish.



CLASSIC SUITE RETREAT

CUSTOM PROGRAM

IT'S EASY TO ORDER YOUR OWN SEATING COMPONENTS.

Just follow this illustration and fill in each circle with the chosen letters.

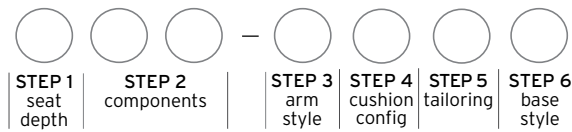

When selecting a leather component, begin the style number with the prefix L. The 8 Series is currently not available in leather.



1. Choose Your Depth

Choose a series number to indicate the depth of your components. For Luxury 8 Series, please complete order using the **Luxury Suite Retreat** program sheet

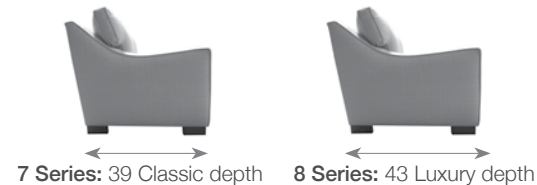

CLASSIC 7 SERIES - 39 DEPTH



Depth:	39"
Height:	36" with Concealed Leg* 36.75" with Square Leg or Angled Leg
Seat Height:	18" with Concealed Leg* 18.75" with Square or Angled Leg
Arm Height:	23.75" with Concealed Leg* 24.5" with Square or Angled Leg* *Unless otherwise noted
Inside Seat Depth:	22"

2. Choose Your Components

CLASSIC SUITE RETREAT COMPONENTS

Dimensions listed are for Saddle arm option. For Crossover arm dimension add 1" for each arm on piece. For Slope arm dimension, add 1.5" for each arm on piece. For Track arm dimension, add 2.5" for each arm on piece. For Roll arm dimension, add 4.5" for each arm on piece.

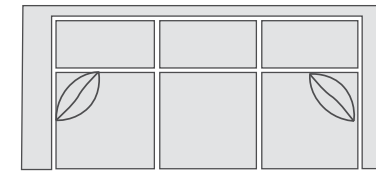

3 Seat Sofa



W84.5 D39 H36
Inside seat W73.5 D22 H18
Standard With Two 20" Throw Pillows

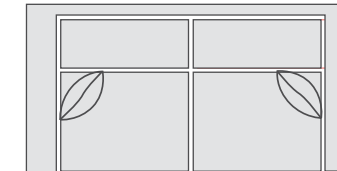

2 Seat Sofa



W78 D39 H36
Inside seat W67 D22 H18
Standard With Two 20" Throw Pillows

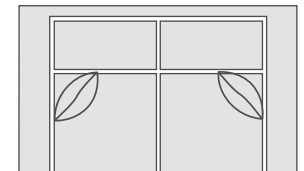

Loveseat

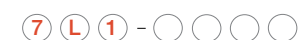

W60 D39 H36
Inside seat W49 D22 H18
Standard With Two 20" Throw Pillows

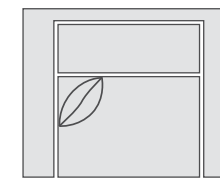

Chair & Half/Swivel



Chair & Half Swivel 7 C 4 - - - - X
W44.5 D39 H36
Inside seat W33.5 D22 H18
Standard With One 20" Throw Pillow

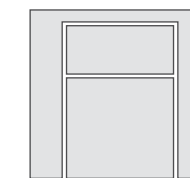

Chair/Swivel



Chair Swivel 7 C 3 - - - - X
W35.5 D39 H36
Inside seat W24.5 D22 H18



Left Arm Corner Sofa



W91 D39 H36
Inside seat W71 D22 H18
Standard With One 20" Throw Pillow



Right Arm Corner Sofa



W91 D39 H36
Inside seat W71 D22 H18
Standard With One 20" Throw Pillow

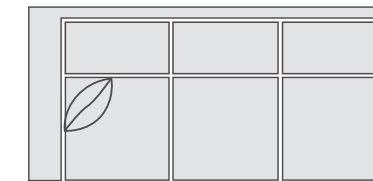

Left Arm Sofa



W79 D39 H36
Inside seat W73.5 D22 H18
Standard With One 20" Throw Pillow



Right Arm Sofa

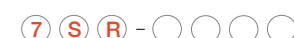

W79 D39 H36
Inside seat W73.5 D22 H18
Standard With One 20" Throw Pillow

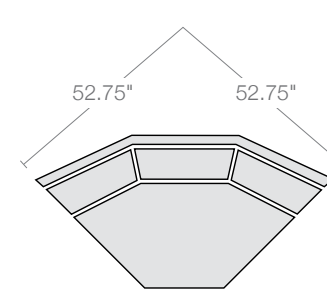

Wedge Corner



Width: 75.5"

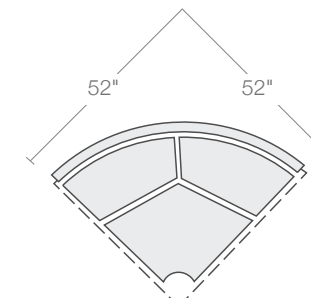

Curved Corner



Width: 73.5"

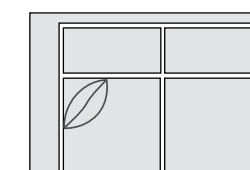

Left Arm Loveseat



W55 D39 H36
Inside seat W49 D22 H18
Standard With One 20" Throw Pillow

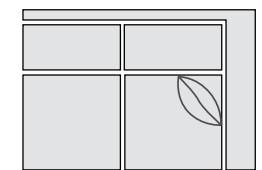

Right Arm Loveseat



W55 D39 H36
Inside seat W49 D22 H18
Standard With One 20" Throw Pillow

CLASSIC SUITE RETREAT COMPONENTS

Dimensions listed are for Saddle arm option. For Crossover arm dimension add 1" for each arm on piece. For Slope arm dimension, add 1.5" for each arm on piece. For Track arm dimension, add 2.5" for each arm on piece. For Roll arm dimension, add 4.5" for each arm on piece.

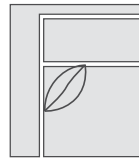

Left Arm Chair

7 E L - ○ ○ ○ ○ ○

W30 D39 H36
Inside seat W26.5 D22 H18
Standard With One 20" Throw Pillow

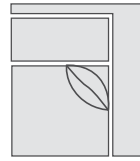

Right Arm Chair

7 E R - ○ ○ ○ ○ ○

W30 D39 H36
Inside seat W26.5 D22 H18
Standard With One 20" Throw Pillow



Armless Chair

7 A 1 - X ○ ○ ○ ○ ○

W24.5 D39 H36
Inside seat W24.5 H18



Armless Loveseat

7 L O - X ○ ○ ○ ○ ○

W49 D39 H36
Inside seat W49 D22 H18

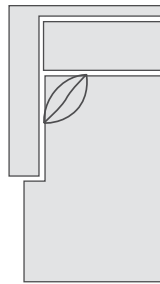

Left Arm Chaise

7 C L - ○ ○ ○ ○ ○

W33 D65 H36
Inside seat W27.5 D48 H18
Standard With One 20" Throw Pillow

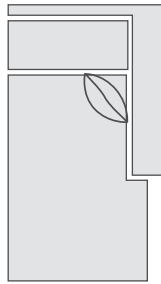

Right Arm Chaise

7 C R - ○ ○ ○ ○ ○

W33 D65 H36
Inside seat W27.5 D48 H18
Standard With One 20" Throw Pillow



Armless Love Seat

7 B O - X ○ ○ ○ ○ ○

W62.5 D39 H36
Inside seat W62.5 D22 H18



Armless Sofa

7 S O - X ○ ○ ○ ○ ○

W73.5 D39 H36
Inside seat W73.5 D22 H18

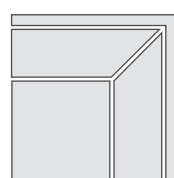

Corner Chair

7 E 1 - X ○ ○ ○ ○ ○

W39 D39 H36
Inside seat W22 D22 H18

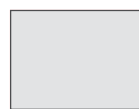

Ottoman

7 O 1 - X X ○ ○ ○ ○ ○

W32 D22 H16.5
*Height is 17.25 with Square Leg or Angled Leg

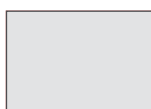

Ottoman & Half

7 O H - X X ○ ○ ○ ○ ○

W38 D26 H16.5
*Height is 17.25 with Square Leg or Angled Leg

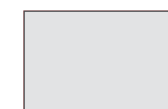

Storage Caster Ottoman

7 O S - X X ○ ○ X

W37 D25 H17.5

3. Choose Your Arm Style ○ ○ ○ - ● ○ ○ ○ ○



N Crossover



T Track



R Roll



P Sloped



O Saddle

4. Choose Your Back Style ○ ○ ○ - ○ ● ○ ○ ○



B Boxed



K Knife Edge

Selecting the **B-Boxed Back Style**, in combination with either the **R-Roll Arm** or **T-Track Arm**, will result in a T-cushion back. All other combinations are standard with a straight edge back cushion.

5. Choose Your Tailoring ○ ○ ○ - ○ ○ ○ ● ○



U Unwelted



W Welted

6. Choose Your Base Style ○ ○ ○ - ○ ○ ○ ● ○



C Concealed

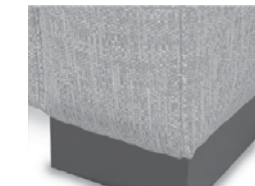

S Square

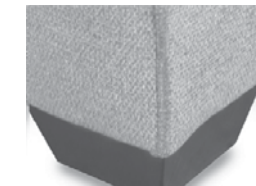

A Angled Leg

S-Square and **A-Angled Legs** are standard Walnut finish. Optional finish Cinder, Desert, Ebony, Ember, Fawn, French Oak, Fruitwood, Kahlua, Smoked, Soho, and Sugar.

Dimensions listed are for Saddle arm option. For Crossover arm dimension add 1" for each arm on piece. For Slope arm dimension, add 2.5" for each arm on piece. For Track arm dimension, add 2.5" for each arm on piece. For Roll arm dimension, add 4.5" for each arm on piece.

8DL-PBUS Suite Retreat Luxury Left Arm Corner Sofa
8SR-PBUS Suite Retreat Luxury Right Arm Sofa
L3427-03 Eastwood Leather Ottoman
111WBP-1011 Keith 2 Door Chest



LUXURY SUITE RETREAT

CUSTOM PROGRAM

IT'S EASY TO ORDER YOUR OWN SEATING COMPONENTS.

Just follow this illustration and fill in each circle with the chosen letters.

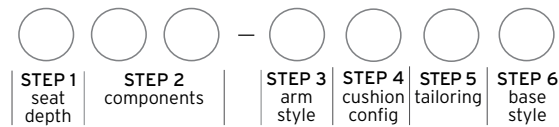

1. Choose Your Depth

Choose a series number to indicate the depth of your components. For Classic 7 Series, please complete order using the Classic Suite Retreat program sheet.

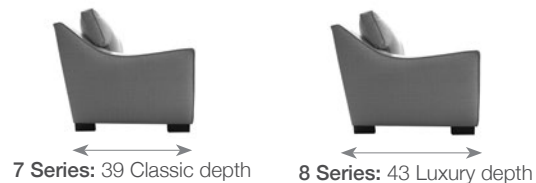

LUXURY 8 SERIES - 43 DEPTH

8 Series currently not available in leather



Depth:	43"
Height:	38" with Concealed Leg* 38.75" with Square Leg or Angled Leg
Seat Height:	18" with Concealed Leg* 18.75" with Square or Angled Leg
Arm Height:	23.75" with Concealed Leg* 24.5" with Square or Angled Leg* *Unless otherwise noted
Inside Seat Depth:	26"

2. Choose Your Components

LUXURY SUITE RETREAT COMPONENTS

Dimensions listed are for Saddle arm option. For Crossover arm dimension add 1" for each arm on piece. For Slope arm dimension, add 1.5" for each arm on piece. For Track arm dimension, add 2.5" for each arm on piece. For Roll arm dimension, add 4.5" for each arm on piece.

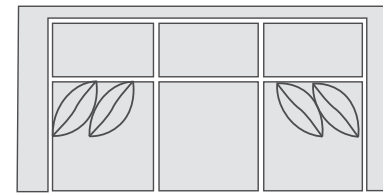

3 Seat Sofa

8 S 1 - ○ ○ ○ ○ ○

W90.5 D43 H38
Inside seat W79.5 D26 H20
Standard With Four 20" Throw Pillows

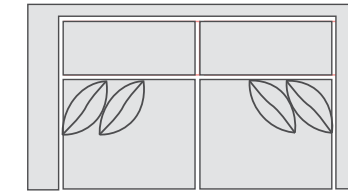

2 Seat Sofa

8 B 1 - ○ ○ ○ ○ ○

W78 D43 H38
Inside seat W67 D26 H20
Standard With Four 20" Throw Pillows

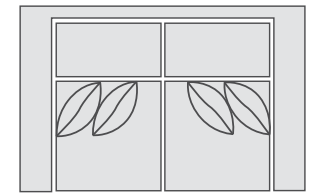

Loveseat

8 L 1 - ○ ○ ○ ○ ○

W64 D43 H38
Inside seat W53 D26 H20
Standard With Four 20" Throw Pillows

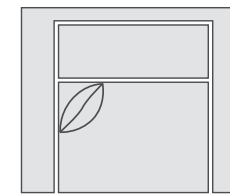

Chair & Half/Swivel

Chair & Half 8 C H - ○ ○ ○ ○ ○
Swivel Chair & Half 8 C 4 - ○ ○ ○ ○ X

W44.5 D43 H38
Inside seat W33.5 D26 H20
Standard With One 20" Throw Pillow

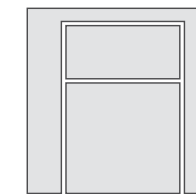

Chair/Swivel

Chair 8 C 1 - ○ ○ ○ ○ ○
Swivel 8 C 3 - ○ ○ ○ ○ X

W37.5 D43 H38
Inside seat W26.5 D26 H20

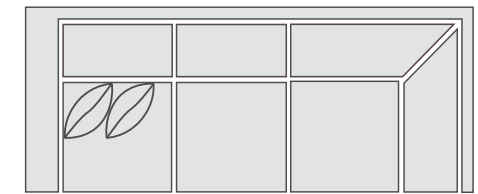

Left Arm Corner Sofa

8 D L - ○ ○ ○ ○ ○

W99 D43 H38
Inside seat W77 D26 H20
Standard With Two 20" Throw Pillows



Right Arm Corner Sofa

8 D R - ○ ○ ○ ○ ○

W99 D43 H38
Inside seat W77 D26 H20
Standard With Two 20" Throw Pillows

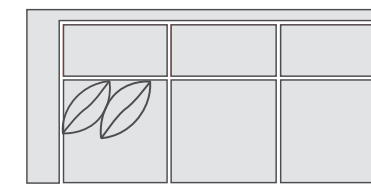

Left Arm Sofa

8 S L - ○ ○ ○ ○ ○

W85 D43 H38
Inside seat W79.5 D26 H20
Standard With Two 20" Throw Pillows

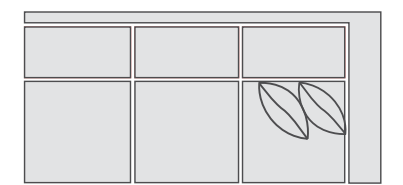

Right Arm Sofa

8 S R - ○ ○ ○ ○ ○

W85 D43 H38
Inside seat W79.5 D26 H20
Standard With Two 20" Throw Pillows

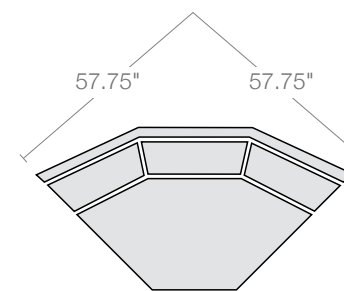

Wedge Corner

8 C W - X ○ ○ ○ ○ ○

Width: 80.5

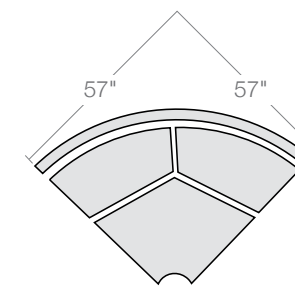

Curved Corner

8 C U - X ○ ○ ○ ○ ○

Width: 78.5

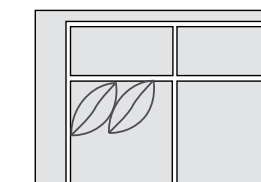

Left Arm Loveseat

8 L L - ○ ○ ○ ○ ○

W59 D43 H38
Inside seat W53 D26 H20
Standard With Two 20" Throw Pillows

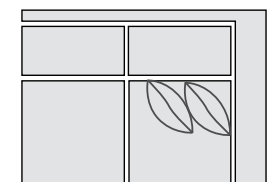

Right Arm Loveseat

8 L R - ○ ○ ○ ○ ○

W59 D43 H38
Inside seat W53 D26 H20
Standard With Two 20" Throw Pillows

1/4" = 1' scale

LUXURY SUITE RETREAT COMPONENTS

Dimensions listed are for Saddle arm option. For Crossover arm dimension add 1" for each arm on piece. For Slope arm dimension, add 1.5" for each arm on piece. For Track arm dimension, add 2.5" for each arm on piece. For Roll arm dimension, add 4.5" for each arm on piece.

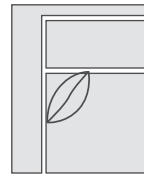

Left Arm Chair

(8) (E) (L) - ○ ○ ○ ○ ○

W32 D43 H38
Inside seat W26.5 D26 H20
Standard With One 20" Throw Pillow

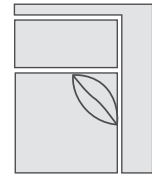

Right Arm Chair

(8) (E) (R) - ○ ○ ○ ○ ○

W32 D43 H38
Inside seat W26.5 D26 H20
Standard With One 20" Throw Pillow



Armless Chair

(8) (A) (1) - (X) ○ ○ ○ ○ ○

W26.5 D26 H38
Inside seat W26.5 D26 H20



Armless Love Seat

(8) (L) (O) - (X) ○ ○ ○ ○ ○

W53 D43 H38
Inside seat W53 D26 H20

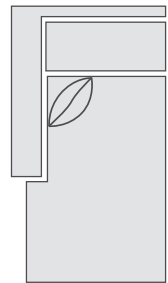

Left Arm Chaise

(8) (C) (L) - ○ ○ ○ ○ ○

W33 D65 H38
Inside seat W27.5 D48 H20
Standard With One 20" Throw Pillow

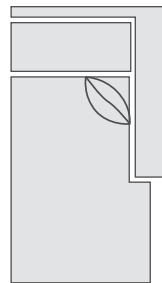

Right Arm Chaise

(8) (C) (R) ○ ○ ○ ○ ○

W33 D65 H38
Inside seat W27.5 D48 H20
Standard With One 20" Throw Pillow



Armless Love Seat

(8) (B) (O) - (X) ○ ○ ○ ○ ○

W62.5 D43 H38
Inside seat W62.5 D26 H20



Armless Sofa

(8) (S) (O) - (X) ○ ○ ○ ○ ○

W79.5 D43 H38
Inside seat W79.5 D26 H20

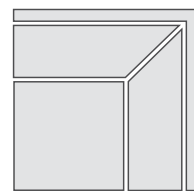

Corner Chair

(8) (E) (1) - (X) ○ ○ ○ ○ ○

W42.5 D43 H38
Inside seat W26 D26 H20



Ottoman

(8) (O) (1) - (X) (X) ○ ○ ○ ○ ○

W34 D22 H*16.5
*Height is 17.25 with Square Leg or Angled Leg

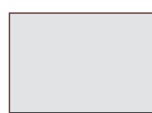

Ottoman & Half

(8) (O) (H) - (X) (X) ○ ○ ○ ○ ○

W38 D26 H*16.5
*Height is 17.25 with Square Leg or Angled Leg

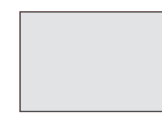

Storage Caster Ottoman

(8) (O) (S) - (X) (X) (X) ○ ○ ○ ○ ○

W37 D25 H17.5

3. Choose Your Arm Style ○ ○ ○ ○ - ● ○ ○ ○ ○



(N) Crossover



(T) Track



(R) Roll



(P) Sloped



(O) Saddle

4. Choose Your Back Style ○ ○ ○ ○ - ○ ● ○ ○ ○ ○



(B) Boxed



(K) Knife Edge

Selecting the B-Boxed Back Style, in combination with either the R-Roll Arm or T-Track Arm, will result in a T-cushion back. All other combinations are standard with a straight edge back cushion.

5. Choose Your Tailoring ○ ○ ○ ○ - ○ ○ ○ ● ○ ○



(U) Unwelted



(W) Welted

6. Choose Your Base Style ○ ○ ○ ○ - ○ ○ ○ ○ ●



(C) Concealed

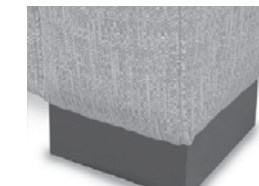

(S) Square

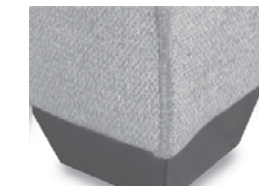

(A) Angled Leg

S-Square and A-Angled Legs are standard Walnut finish. Optional finish Cinder, Desert, Ebony, Ember, Fawn, French Oak, Fruitwood, Kahlua, Smoked, Soho, and Sugar.

Dimensions listed are for Saddle arm option. For Crossover arm dimension add 1" for each arm on piece. For Slope arm dimension, add 2.5" for each arm on piece. For Track arm dimension, add 2.5" for each arm on piece. For Roll arm dimension, add 4.5" for each arm on piece.



MODERN INTUITION

CUSTOM PROGRAM

IT'S EASY TO ORDER YOUR OWN UPHOLSTERED SEATING.

Just follow this illustration and fill in each circle with your selection. Repeat for each component.

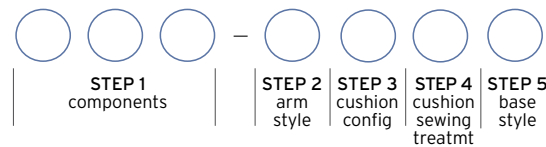

1. Choose Your Components 9 ● ● - ○ ○ ○ ○ ○

2. Choose Your Arm Style 9 ○ ○ ○ - ● ○ ○ ○ ○

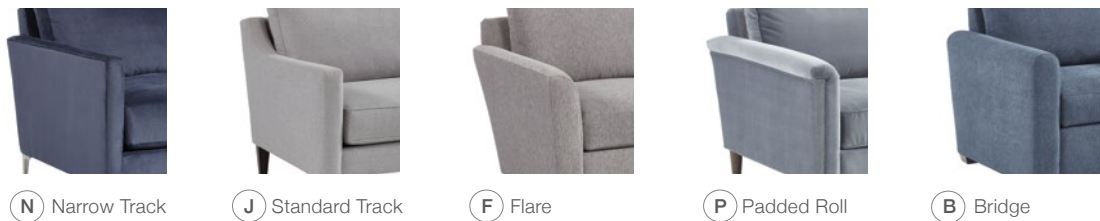

3. Choose Your Cushion Configuration 9 ○ ○ ○ - ○ ● ○ ○ ○



4. Choose Your Cushion Sewing Treatment 9 ○ ○ ○ - ○ ○ ● ○ ○



5. Choose Your Base Style 9 ○ ○ ○ - ○ ○ ○ ○ ●



S - Square Taper Leg (6.5"), R - Round Taper Leg (6.5") & A - Angled Block Foot (1.5") are standard Walnut finish.
Optional wood finishes Cinder, Desert, Ebony, Ember, Fawn, French Oak, Fruitwood, Kahlua, Smoked, Soho and Sugar. Available at no upcharge.
H - Hidden Foot, no optional finishes available.

TWO OVER ONE CUSHION CONFIGURATIONS

Seat Height: 18"

Dimensions listed are for Narrow Track Arm option. For Standard Track Arm dimensions, add 1.5" for each arm on piece.
For Padded Roll Arm dimensions, add 2.5" for each arm on piece. For Bridge Arm and Flare Arm dimensions, add 3" for each arm on piece.
Overall widths vary, depending on arm option chosen.

Sofa
9 S 1 - ○ ○ ○ ○ ○
W85.5 D38 H33
Inside Seat W79.5 D22 H15
Standard With Two 20" Throw Pillows

Long Sofa
9 S 2 - ○ ○ ○ ○ ○
W90.5 D38 H33
Inside Seat W84 D22 H15
Standard With Two 20" Throw Pillows

Short Sofa
9 B 1 - ○ ○ ○ ○ ○
W75.5 D38 H33
Inside Seat W69.5 D22 H15
Standard With Two 20" Throw Pillows

Left Arm Sofa
9 S L - ○ ○ ○ ○ ○
W82.5 D38 H33
Inside Seat W79.5 D22 H15
Standard With One 20" Throw Pillow

Right Arm Sofa
9 S R - ○ ○ ○ ○ ○
W82.5 D38 H33
Inside Seat W79.5 D22 H15
Standard With One 20" Throw Pillow

Loveseat
9 L 1 - ○ ○ ○ ○ ○
W60 D38 H33
Inside Seat W53 D22 H15
Standard With Two 20" Throw Pillows

Armless Loveseat
9 L O - X ○ ○ ○ ○
W53.5 D38 H33
Inside Seat W53.5 D22 H15

Left Arm Loveseat
9 L L - ○ ○ ○ ○ ○
W56 D38 H33
Inside Seat W53 D22 H15
Standard With One 20" Throw Pillow

Right Arm Loveseat
9 L R - ○ ○ ○ ○ ○
W56 D38 H33
Inside Seat W53 D22 H15
Standard With One 20" Throw Pillow

Left Arm Corner Sofa
9 D L - ○ ○ ○ ○ ○
W94 D38 H33
Inside Seat W79.5 D22 H15
Standard With One 20" Throw Pillow

Right Arm Corner Sofa
9 D R - ○ ○ ○ ○ ○
W94 D38 H33
Inside Seat W79.5 D22 H15
Standard With One 20" Throw Pillow

Armless Sofa
9 S O - X ○ ○ ○ ○
W80 D38 H33
Inside Seat W80 D22 H15

Chair
9 C 1 - ○ X ○ ○ ○
W32.5 D38 H33
Inside Seat W26.5 D22 H15

Armless Chair
9 A 1 - X X ○ ○ ○
W27 D38 H33
Inside Seat W27 D22 H15

Inside Corner
9 E 1 - X X ○ ○ ○
W38 D38 H33
Inside Seat W22 D22 H15

Ottoman
9 O 1 - X X ○ ○ ○
W28 D23 H17

Wedge
9 C U - X X ○ ○ ○
W73.5 D41 H33
Inside Seat W42 D22 H15
Standard With Two 20" Throw Pillows

Left Arm Chaise
9 C L - ○ X ○ ○ ○
W33 D64 H33
Inside Seat W30 D49 H15
Standard With One 20" Throw Pillow

Right Arm Chaise
9 C R - ○ X ○ ○ ○
W33 D64 H33
Inside Seat W30 D49 H15
Standard With One 20" Throw Pillow

Left Arm Chair
9 E L - ○ X ○ ○ ○
W29.5 D38 H33
Inside Seat W26.5 D22 H15
Standard With One 20" Throw Pillow

Right Arm Chair
9 E R - ○ X ○ ○ ○
W29.5 D38 H33
Inside Seat W26.5 D22 H15
Standard With One 20" Throw Pillow

TWO OVER TWO CUSHION CONFIGURATIONS

Seat Height: 18"

Dimensions listed are for Narrow Track Arm option. For Standard Track Arm dimensions, add 1.5" for each arm on piece. For Padded Roll Arm dimensions, add 2.5" for each arm on piece. For Bridge Arm and Flare Arm dimensions, add 3" for each arm on piece.

Overall widths vary, depending on arm option chosen.

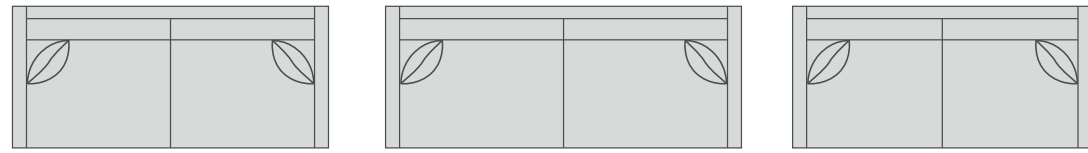

Sofa
 9 S 1 - 0 2 0 0
 W85.5 D38 H33
 Inside Seat W79.5 D22 H15
 Standard With Two 20" Throw Pillows

Long Sofa
 9 S 2 - 0 2 0 0
 W90.5 D38 H33
 Inside Seat W84 D22 H15
 Standard With Two 20" Throw Pillows

Short Sofa
 9 B 1 - 0 2 0 0
 W75.5 D38 H33
 Inside Seat W69.5 D22 H15
 Standard With Two 20" Throw Pillows

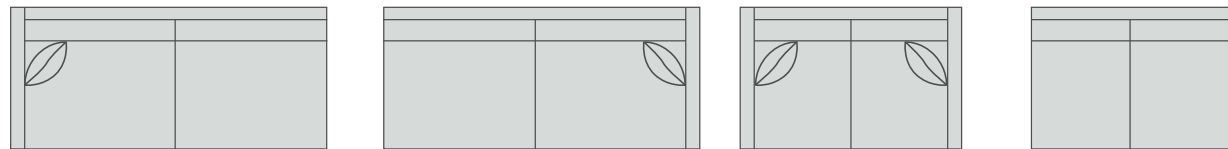

Left Arm Sofa
 9 S L - 0 2 0 0
 W82.5 D38 H33
 Inside Seat W79.5 D22 H15
 Standard With One 20" Throw Pillow

Right Arm Sofa
 9 S R - 0 2 0 0
 W82.5 D38 H33
 Inside Seat W79.5 D22 H15
 Standard With One 20" Throw Pillow

Loveseat
 9 L 1 - 0 2 0 0
 W60 D38 H33
 Inside Seat W53 D22 H15
 Standard With Two 20" Throw Pillows

Armless Loveseat
 9 L 0 - X 2 0 0
 W53.5 D38 H33
 Inside Seat W53.5 D22 H15

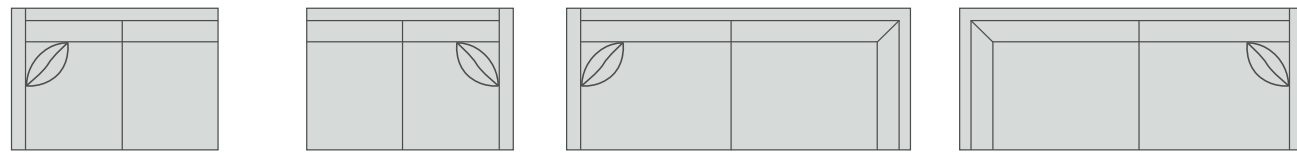

Left Arm Loveseat
 9 L L - 0 2 0 0
 W56 D38 H33
 Inside Seat W53 D22 H15
 Standard With One 20" Throw Pillow

Right Arm Loveseat
 9 L R - 0 2 0 0
 W56 D38 H33
 Inside Seat W53 D22 H15
 Standard With One 20" Throw Pillow

Left Arm Corner
 9 D L - 0 2 0 0
 W94 D38 H33
 Inside Seat W79.5 D22 H15
 Standard With One 20" Throw Pillow

Right Arm Corner Sofa
 9 D R - 0 2 0 0
 W94 D38 H33
 Inside Seat W79.5 D22 H15
 Standard With One 20" Throw Pillow

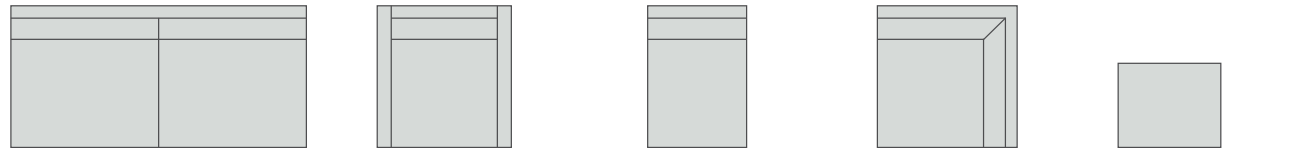

Armless Sofa
 9 S 0 - X 2 0 0
 W80 D38 H33
 Inside Seat W80 D22 H15

Chair
 9 C 1 - 0 X 0 0
 W32.5 D38 H33
 Inside Seat W26.5 D22 H15

Armless Chair
 9 A 1 - X X 0 0
 W27 D38 H33
 Inside Seat W27 D22 H15

Inside Corner
 9 E 1 - X X 0 0
 W38 D38 H33
 Inside Seat W22 D22 H15

Ottoman
 9 O 1 - X X 0 0
 W28 D23 H17

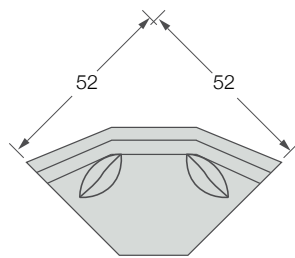

Wedge
 9 C U - X X 0 0
 W73.5 D41 H33
 Inside Seat W42 D22 H15
 Standard With Two 20" Throw Pillows

Left Arm Chaise
 9 C L - 0 X 0 0
 W33 D64 H33
 Inside Seat W30 D49 H15
 Standard With One 20" Throw Pillow

Right Arm Chaise
 9 C R - 0 X 0 0
 W33 D64 H33
 Inside Seat W30 D49 H15
 Standard With One 20" Throw Pillow

Left Arm Chair
 9 E L - 0 X 0 0
 W29.5 D38 H33
 Inside Seat W26.5 D22 H15
 Standard With One 20" Throw Pillow

Right Arm Chair
 9 E R - 0 X 0 0
 W29.5 D38 H33
 Inside Seat W26.5 D22 H15
 Standard With One 20" Throw Pillow

THREE OVER THREE CUSHION CONFIGURATIONS

Seat Height: 18"

Dimensions listed are for Narrow Track Arm option. For Standard Track Arm dimensions, add 1.5" for each arm on piece. For Padded Roll Arm dimensions, add 2.5" for each arm on piece. For Bridge Arm and Flare Arm dimensions, add 3" for each arm on piece.

Overall widths vary, depending on arm option chosen. 1/4" = 1' Scale

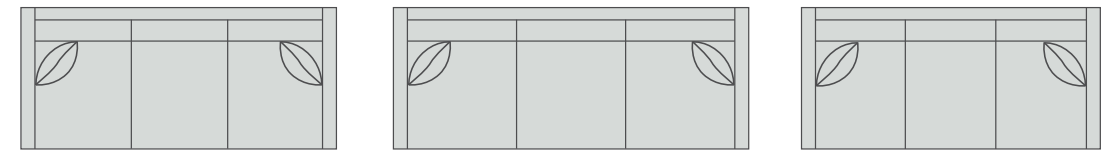

Sofa
 9 S 1 - 0 3 0 0
 W85.5 D38 H33
 Inside Seat W79.5 D22 H15
 Standard With Two 20" Throw Pillows

Long Sofa
 9 S 2 - 0 3 0 0
 W90.5 D38 H33
 Inside Seat W84 D22 H15
 Standard With Two 20" Throw Pillows

Short Sofa
 9 B 1 - 0 3 0 0
 W75.5 D38 H33
 Inside Seat W69.5 D22 H15
 Standard With Two 20" Throw Pillows

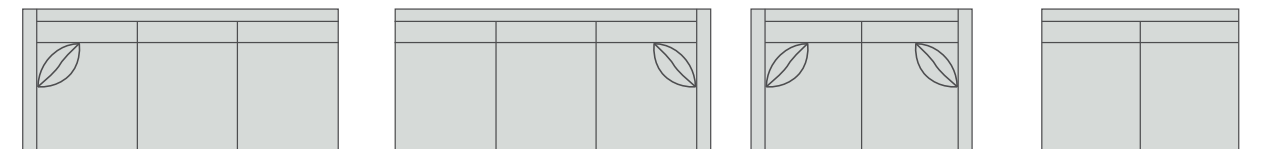

Left Arm Sofa
 9 S L - 0 3 0 0
 W82.5 D38 H33
 Inside Seat W79.5 D22 H15
 Standard With One 20" Throw Pillow

Right Arm Sofa
 9 S R - 0 3 0 0
 W82.5 D38 H33
 Inside Seat W79.5 D22 H15
 Standard With One 20" Throw Pillow

Loveseat
 9 L 1 - 0 3 0 0
 W60 D38 H33
 Inside Seat W53 D22 H15
 Standard With Two 20" Throw Pillows

Armless Loveseat
 9 L 0 - X 3 0 0
 W53.5 D38 H33
 Inside Seat W53.5 D22 H15

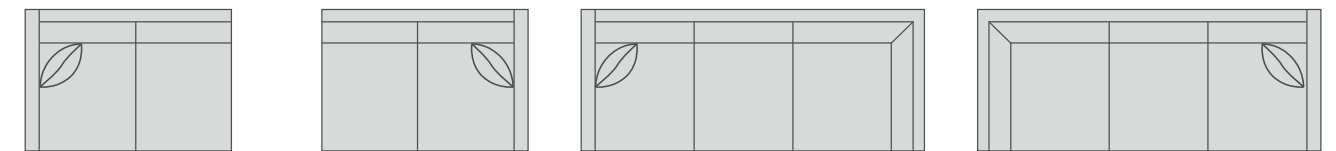

Left Arm Loveseat
 9 L L - 0 3 0 0
 W56 D38 H33
 Inside Seat W53 D22 H15
 Standard With One 20" Throw Pillow

Right Arm Loveseat
 9 L R - 0 3 0 0
 W56 D38 H33
 Inside Seat W53 D22 H15
 Standard With One 20" Throw Pillow

Left Arm Corner
 9 D L - 0 3 0 0
 W94 D38 H33
 Inside Seat W79.5 D22 H15
 Standard With One 20" Throw Pillow

Right Arm Corner Sofa
 9 D R - 0 3 0 0
 W94 D38 H33
 Inside Seat W79.5 D22 H15
 Standard With One 20" Throw Pillow

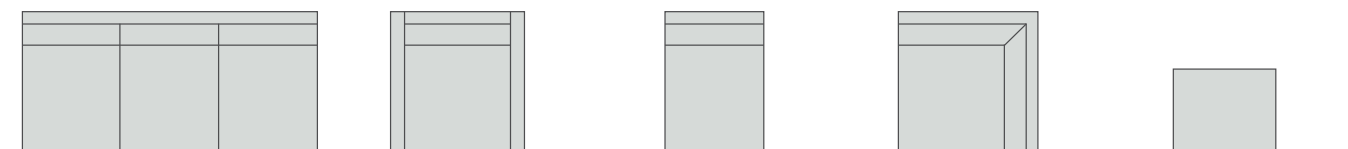

Armless Sofa
 9 S 0 - X 3 0 0
 W80 D38 H33
 Inside Seat W80 D22 H15

Chair
 9 C 1 - 0 X 0 0
 W32.5 D38 H33
 Inside Seat W26.5 D22 H15

Armless Chair
 9 A 1 - X X 0 0
 W27 D38 H33
 Inside Seat W27 D22 H15

Inside Corner
 9 E 1 - X X 0 0
 W38 D38 H33
 Inside Seat W22 D22 H15

Ottoman
 9 O 1 - X X 0 0
 W28 D23 H17

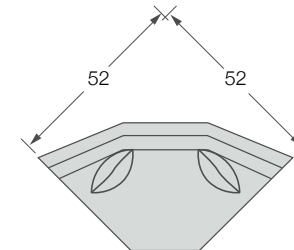

Wedge
 9 C U - X X 0 0
 W73.5 D41 H33
 Inside Seat W42 D22 H15
 Standard With Two 20" Throw Pillows

Left Arm Chaise
 9 C L - 0 X 0 0
 W33 D64 H33
 Inside Seat W30 D49 H15
 Standard With One 20" Throw Pillow

Right Arm Chaise
 9 C R - 0 X 0 0
 W33 D64 H33
 Inside Seat W30 D49 H15
 Standard With One 20" Throw Pillow

Left Arm Chair
 9 E L - 0 X 0 0
 W29.5 D38 H33
 Inside Seat W26.5 D22 H15
 Standard With One 20" Throw Pillow

Right Arm Chair
 9 E R - 0 X 0 0
 W29.5 D38 H33
 Inside Seat W26.5 D22 H15
 Standard With One 20" Throw Pillow



SIGNATURE SIDES

CUSTOM PROGRAM

It's easy to order your own upholstered dining chairs, banquette, barstools or counterstools.

Just follow this illustration and fill in each circle with your selection.

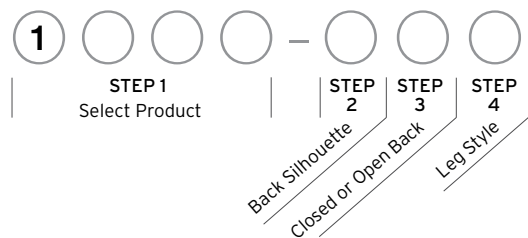

When selecting a leather dining chair, banquette, barstool or counterstool begin the style number with the prefix L.

L 1 0 0 0 - 0 0 0 0

Standard Finish - Walnut. Optional Wood Finishes - Cinder, Desert, Ebony, Fawn, French Oak, Fruitwood, Kahlua, Smoked, Soho and Sugar.

1. Choose Your Product 1 ●●●● - ○○○○ Overall Depth 22"



1 0 D 1

Dining Side Chair - 21w

1 0 D 2

Dining Arm Chair - 25w
Arm Height 25"

1 0 B Q

Dining Banquette - 50w



1 1 B S

Bar Stool - 20w



1 1 C S

Counter Stool - 20w

2. Choose Your Back Silhouette 1 ○○○○ - ●○○○



1 0 0 0 - A 0 0

A Square Straight

1 0 0 0 - B 0 0

B Beveled Straight

1 0 0 0 - C 0 0

C Camel Curve

1 0 0 0 - D 0 0

D Flared Curve
*Limited to 10 Series

1 0 0 0 - E 0 0

E Arc Curve



1 1 0 0 - A 0 0

A Square Straight

1 1 0 0 - B 0 0

B Beveled Straight

1 1 0 0 - C 0 0

C Camel Curve

1 1 0 0 - E 0 0

E Arc Curve

3. Choose Your Back, Closed or Open 1 ○○○○ - ○●○○

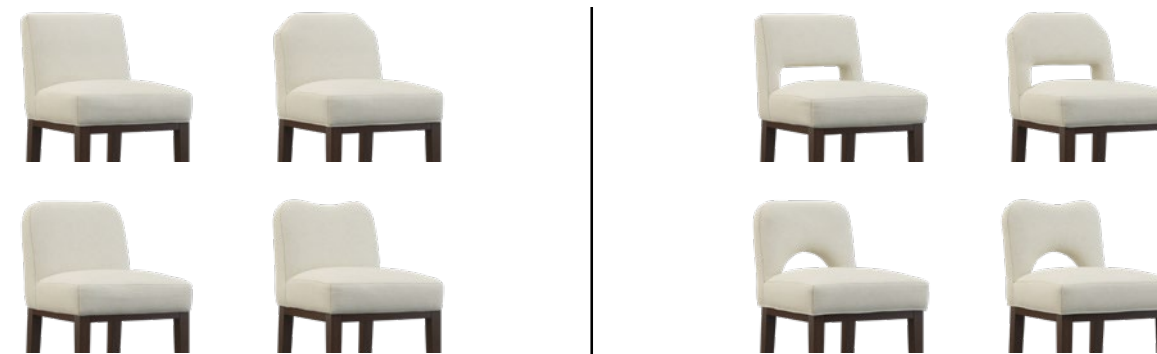

F Fully Upholstered

K Keyhole Opening

4. Choose Your Leg Style 1 ○○○○ - ○○○●



1 0 0 0 - 0 0 R

R Round Taper

1 0 0 0 - 0 0 S

S Square Taper

1 0 0 0 - 0 0 U

U Upholstered Pedestal Base
*Features Hidden Casters



1 1 0 0 - 0 0 R

R Round Stationary

1 1 0 0 - 0 0 S

S Square Stationary

1 1 0 0 - 0 0 V

V Square Swivel

1 1 0 0 - 0 0 W

W Round Swivel

DETAILS

10D1-AKS Signature Sides Dining Side Chair
SER-005D Mado Waterfall Console















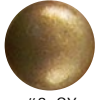













Customize the details to create a bespoke furniture piece expressing your personal style and taste. Decorative nailhead trims can add a touch of elegance, while the wood finish can either complement or contrast with your existing decor. Choosing the right throw pillows can make your furniture more comfortable and visually appealing, while cushion firmness can be adapted to provide the perfect level of support. Precedent's made to order furniture, enables you to create one-of-a-kind pieces that truly reflect who you are.

<i>Nailhead Trim Finishes.....</i>	<i>215</i>
<i>Kickplate Finishes</i>	<i>216</i>
<i>Sleeper Mechanisms</i>	<i>216</i>
<i>Mattress Specs</i>	<i>216</i>
<i>Pillows</i>	<i>217</i>
<i>Cushions.....</i>	<i>218</i>
<i>Leg & Arm Finishes.....</i>	<i>219</i>

NAILHEAD TRIM FINISHES

We offer decorative nails on many of our frames to add just the right accent or closing trim. Images are not actual size.

Finish	#1 Size	#3 Size	Finish	#1 Size	#3 Size	Finish	#1 Size	#3 Size
A-ANTIQUÉ			G-GOLD			OX-OXFORD		
AB-ANTIQUÉ BLACK			GM-GUN METAL			P-PLATINUM		
BB-BRIGHT BRASS			N-NATURAL			PN-POLISHED NICKEL		
BZ-BRONZE			NN-BLACK NICKEL			V-VINTAGE		
FN-FRENCH NATURAL			OB-OLD BRASS					

Some styles are standard with small/#1 nailhead trim and are so noted in the pricelist. Please specify - Small Brass/#1-BB Bright Brass, Small Chrome/#1-PN Polished Nickel, Small Cinder/#1-NN Black Nickel, Small French Natural/#1-FN French Natural or Small Platinum/#1-P Platinum.

On some styles that are standard with small/#1 nails, large/#3 spaced nails may be applied in a single row to the front and sides of the base and are so noted in the pricelist. Please specify - Large Brass/#3-BB Bright Brass, Large Chrome/#3-PN Polished Nickel, Large Cinder/#3-NN Black Nickel, Large French Natural/#3 French Natural or Large Platinum/#3-P Platinum.

On styles with standard nailhead trim, the nails may be omitted. The order must specify to omit nailhead trim.

Some styles are available with optional small/#1 nailhead trim at an upcharge and are so noted in the pricelist. Please specify - Small Brass/#1-BB Bright Brass, Small Chrome/#1-PN Polished Nickel, Small Cinder/#1-NN Black Nickel, Small French Natural/#1-FN French Natural or Small Platinum/#1-P Platinum.



Some styles are available with optional large/#3 spaced nails at an upcharge and may be applied in a single row to the front and sides of the base and are so noted in the pricelist. Please specify - Large Brass/#3-BB Bright Brass, Large Chrome/#3-PN Polished Nickel, Large Cinder/#3-NN Black Nickel, Large French Natural/#3 French Natural or Large Platinum/#3-P Platinum.

Additional Nail Finish options are available and can be found by visiting precedent-furniture.com or sherrilldealers.com. Location of the nail application will be specific to each style. Nails may be applied to the front and sides of the base (not the back) and on the arms, where applicable. Contact Customer Service with questions regarding nail placement on specific styles.

[View Nailhead Trim online](#)

KICKPLATE FINISHES

Kickplates are available in French Natural or Platinum finish. Finish must be specified on order. Images are not actual size.



French Natural



Platinum

We suggest French Natural Kickplate for:

- Antique Nail
- Bright Brass Nail
- Bronze Nail
- French Natural Nail
- Gold Nail
- Natural Nail
- Old Brass Nail
- Oxford Nail
- Vintage Nail

We suggest Platinum Kickplate for:

- Antique Black Nail
- Black Nickel Nail
- Gun Metal Nail
- Polished Nickel Nail
- Platinum Nail
- Polished Nickel Nail

SLEEPER MECHANISMS & MATTRESS SPECIFICATIONS



Mechanism

Double Locking TV Headrest - provides added comfort while lounging or watching TV by raising the upper body.

All Tubular Frame Construction & Dual One Piece Tubular Legs - provide enhanced stability and strength by allowing the unit to be operated from the center and side position.

Extended Deck Coverage - the polypropylene decking is designed to extend beyond the metal frame and linkage parts eliminating any metal to upholstery contact.

Seat Support Wires - provides support while sleeping, plus adding durability to the overall unit. Support wires also give the quality feel of stationary seating.

Mattress

Standard with 5" Innerspring Mattress. Queen size mattress 60" x 73" - standard in Q1, QL, QR. Full size mattresses 54" x 73" - standard in R1. Single mattress 32" x 72" - standard in T1.

Securely locked cover insulation - unique tufting locks the cover and cushioning material into place, prevents it from bunching, making it easier to fold and store.

Longer life and more support - inner springs are totally oven tempered, giving the units "memory". The units have resiliency which provides longer lasting performance.

Luxurious deep comfort - cover is quilted to a thick layer of Kingsdown quality foam.

Reduced coil and edge feel - fully enclosed spring unit is bonded with Flexatron insulation for permanent shaping, hugging the edges so it can never shift, lump or bunch.

Allergy free, Odor-free, Mildew resistant - Flexatron is a blend of all man made fibers, thermally bonded at over 400° F, providing a hypoallergenic padding material that will not host mold or mildew.

Air Dream Mattress

Air over coil technology creates a sleep surface with the comfort and support that rivals premium mattresses.

Operates with a lightweight, convenient, handheld, quick fill electric pump (included). Air Dream mattress inflates in 45 seconds, deflates in 30 seconds.

Available at an upcharge on Q1, QL, QR (Queen Sleepers) & R1 (Full Sleepers). Not available on T1.

PILLOWS

Adding decorative pillows to your Precedent seating can help further define your own personal style. See below for all pillow shapes and sizes and refer to the price list for more information.

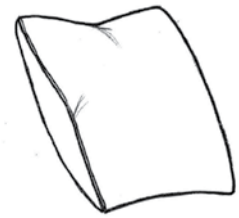

- P-100 18" Pillow - Knife Edge
- P-101 20" Pillow - Knife Edge
- P-103 22" Pillow - Knife Edge
- P-104 25" Pillow - Knife Edge
- P-400 22" Pillow - Knife Edge (Restricted to Mongolian)

C-100 18" Pillow - Knife Edge (Standard with Contrasting Back in linen fabric)



- P-105 14" x 24" Kidney Pillow - Knife Edge
- P-108 14" x 25½" Kidney Pillow - Knife Edge
- P-109 12" x 16" Kidney Pillow - Knife Edge
- P-110 21" x 27" Kidney Pillow - Knife Edge



P-107 6" x 21" Cylinder Pillow

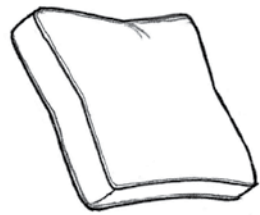

- P-200 18" Pillow - Box Border
- P-201 20" Pillow - Box Border
- P-203 22" Pillow - Box Border
- P-204 25" Pillow - Box Border



- P-205 14" x 24" Kidney Pillow - Box Border
- P-208 14" x 25½" Kidney Pillow - Box Border

CUSHIONS

At Precedent, we're all about comfort, and nothing effects the comfort of your sofa or chair like the cushion. Each type of cushion is created with your comfort in mind. We select a standard cushion for each style, but optional cushion types are available on many styles. Please refer to your price list for available options.



UD Seat Cushion (UD) - A combination of premium urethane foam with a soft cell foam layer applied to the top and bottom, then sewn into a ticking.



Comfort Firm Seat (CFS) - The comfort firm cushion is engineered the same as the Luxury Spring Seat, except stronger springs and firmer foam are utilized to give a firmer seat.



Luxury Spring Seat (LSS) - A cushion that features a Marshall spring unit which is encased in a high resiliency urethane core. Then a soft-cell foam layer is applied to the top and bottom and is sewn into a ticking.



Plush Down Seat Cushion (PDS) This cushion features a combination of premium high resiliency urethane foam with a soft cell foam layer applied to the top and bottom. The foam core is then encased in a jacket of 100% blended feathers and down.



Ultra Lux Seat Cushion (ULS) - A cushion that features a Marshall spring unit which is encased in high resiliency foam. Then a soft-cell foam layer is applied to the top and bottom and it is encased in a jacket of 100% blended feathers and down.



View Pillow options online



View Cushion options online

LEG & ARM FINISHES

Please refer to pricing pages for finishes available on each style.
A standard finish is noted for each style and will be applied to orders with no specified finish. Reference pricelist for all details.



View Finish options online



Cinder



Desert



Fruitwood



Kahlua



Ebony

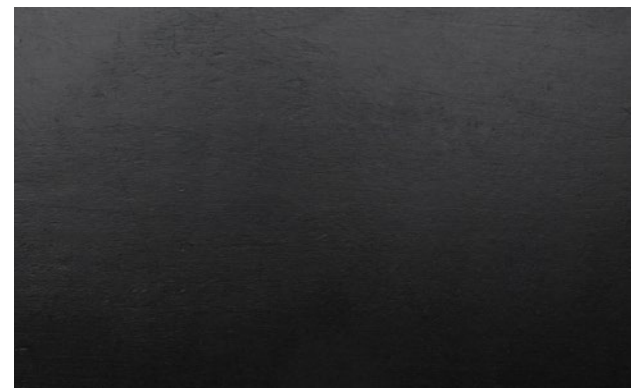

Ember

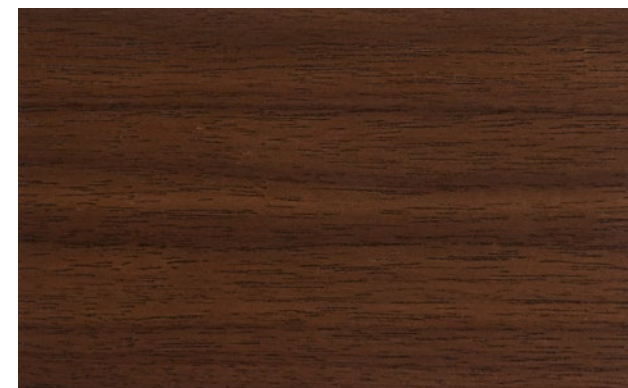

Smoked

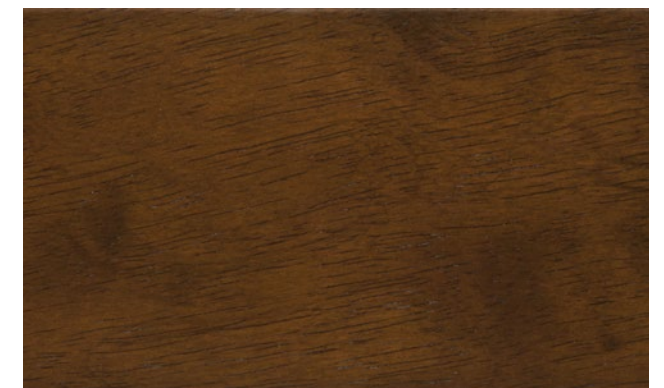

Soho

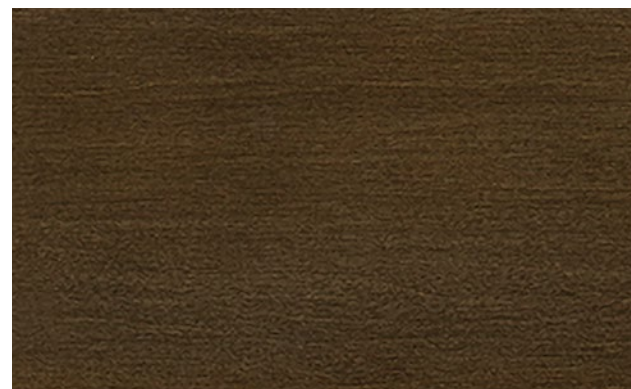

Fawn



French Oak



Sugar

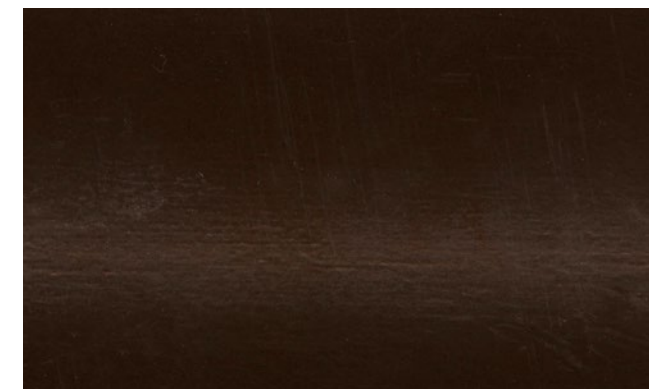

Walnut

Wood is a natural product: Grain pattern and color may vary from piece to piece and within the same piece, therefore samples are for reference only. Actual finish may vary.

3436-S2 Navie Curved Sofa
3452-C1 Sabrina Chair
SER-009 Olin Round Cocktail Table
SER-010 Olin Round End Table
SER-005D Mado Console Table



PRECEDENT-FURNITURE.COM

Our website not only allows you to search our amazing upholstery items, but includes all inspirational imagery, product specifications, downloadable content, fabrics and more. The site walks through each Studio P Custom Program and is constantly being updated. Visit us today to learn more.

VIEW HUNDREDS OF FABRIC SWATCHES

Sort through our extensive fabric collection with the ability to filter by brand, grade and color.

LEARN MORE ABOUT US

Did you know that every Precedent upholstery item is crafted in our Newton, NC facility? Learn more about our capabilities and watch our video.

DOWNLOAD STUDIO P ORDER SHEETS

We make ordering any of our custom programs easy with downloadable order sheets that are ready to print, complete and order.

SAVE YOUR FAVES

Log in and save your favorite Precedent items. With the ability to print, share, save and email the specs, we make it easy to organize your wish list.



TAKE
ADVANTAGE
OF OUR
QR CODES

Save time! Scan QR codes to access product web pages directly.

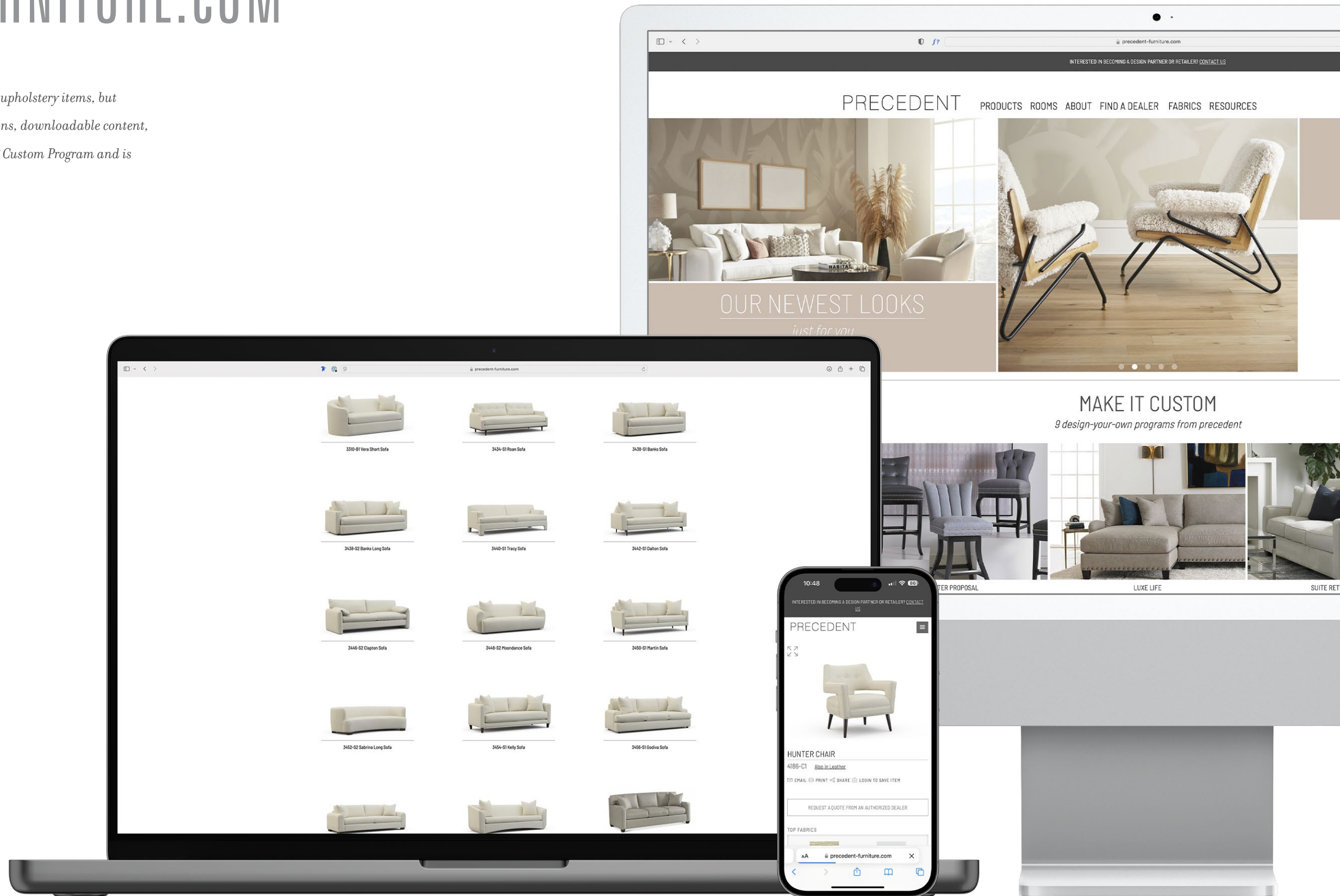

INDEX

3456-S1 Godiva Sofa
3440-S1 Tracy Sofa
3531-C1 Tuttle Chair
MH26313-90 Hutch Cocktail Table
MH25322-91 Rataan Spot Table



INDEX BY NUMBER

130-QHR Mackenzie Queen Headboard & Rails	Page 90	3027-C1 Cary Chair	Page 43
158-QHR Caleb Queen Headboard & Rails.....	Page 90	3119-C3 Gordon Swivel Chair	Page 58
160-QOS Peyton Queen Storage Ottoman.....	Page 80	3130-D1 Nora Dining Side Chair	Page 76
161-QHR Beckett Queen Headboard & Rails.....	Page 92	3134-01 Drew Button Tufted Ottoman	Page 81
161-QHS Beckett Queen Headboard, Rails & Storage Drawer	Page 92	3149-S1 Braden Sofa	Page 12
176-QHR Nebo Queen Headboard & Rails	Page 93	3155-S1 Blake Sofa	Page 12
178-KHR Slater King Headboard & Rails	Page 93	3168-C3 Phillip Swivel Chair.....	Page 58
178-QHR Slater Queen Headboard & Rails	Page 94	3169-C3 Ramsey Swivel Chair	Page 58
178-THR Slater Twin Headboard & Rails	Page 94	3182 Bailey Series Sectional	Page 115
180-QHR Forbes Queen Headboard & Rails	Page 95	3182-S1 Bailey Sofa	Page 13
2090-02 Elliot Caster Ottoman	Page 80	3186-C1 Natalie Chair	Page 43
2107-C1 Rona Chair.....	Page 42	3192-C3 Sherman Swivel Chair	Page 59
2107-01 Rona Ottoman	Page 42	3200-C1 Tristen Chair	Page 43
2145 Ethan Series Sectional	Page 99	3200-01 Tristen Ottoman.....	Page 43
2145-S2 Ethan 3 Cushion Sofa.....	Page 9	3201-C1 Courtney Chair.....	Page 43
2233-K1 Mia Caster Keg Ottoman	Page 80	3208-C1 Grant Chair.....	Page 44
2233-K2 Mia Caster Keg Ottoman	Page 80	3209-C1 Erik Chair	Page 44
2233-K3 Mia Caster Keg Ottoman	Page 80	3209-01 Erik Ottoman.....	Page 44
2338-02 Leah Caster Round Ottoman.....	Page 81	3226-B1 Erin Bench.....	Page 40
2541-01 Gavyn Ottoman.....	Page 81	3229-C1 Bella Chair	Page 44
2557-C3 Dalton Swivel Chair.....	Page 58	3233-C1 Aria Chair.....	Page 44
259-QHR Roxanne Queen Headboard & Rails.....	Page 95	3240-S1 Lindsay Sofa.....	Page 13
2594-D1 Luc Dining Side Chair	Page 75	3241-CL Sansa Left Arm Chaise.....	Page 40
2598-D1 Reid Dining Side Chair	Page 75	3241-CR Sansa Right Arm Chaise.....	Page 40
2598-D2 Reid Dining Arm Chair	Page 75	3242-S1 Kenzie Sofa	Page 13
2665 Jake Series Sectional	Page 103	3252-S1 Corbin Standard Sofa.....	Page 14
2665-S3 Jake Long Sofa.....	Page 9	3257-C3 Tara Swivel Chair	Page 59
2666 Kylie Series Sectional	Page 105	3273-C3 Kathleen Swivel Chair.....	Page 59
2667 Connor Series Sectional.....	Page 109	3275-C1 Kimberly Chair	Page 46
2667-S1 Connor Short Sofa.....	Page 9	3276-S1 Michelle Sofa	Page 15
2668 Marshall Series Sectional.....	Page 111	3279-C1 Kayla Chair.....	Page 46
2668-S2 Marshall Standard Sofa	Page 10	3279-01 Kayla Ottoman.....	Page 46
2723-C1 Winston Chair.....	Page 42	3280 Nicole Series Sectional.....	Page 119
2727-C1 Fisher Chair	Page 42	3280-S1 Nicole Standard Sofa.....	Page 15
2753-D2 Ella Arm Chair	Page 42, 75	3282 Hilton Series Sectional	Page 120
2913-D1 Cora Dining Side Chair.....	Page 76	3282-S2 Hilton Long Sofa.....	Page 15
3015 Oliver Series Sectional	Page 113	3286-S1 Michael Sofa.....	Page 16
3015-S1 Oliver Sofa.....	Page 11	3310-B1 Vera Short Sofa.....	Page 16
3016-S2 Jennifer Long Sofa	Page 12	3310-S1 Vera Standard Sofa.....	Page 16
		3313-C3 Luna Swivel Chair	Page 59

INDEX BY NUMBER

3320-S1 Zelda Sofa	Page 17	3423-OC Elon Office Chair	Page 72
3321-01 Tina Round Ottoman.....	Page 81	3424-S2 Dover Sofa	Page 24
3321-03 Tina Round Ottoman	Page 81	3425-01 Lorie Ottoman	Page 82
3321-04 Tina Square Ottoman	Page 82	3427-D2 Rainier Dining Arm Chair.....	Page 77
3321-05 Tina Small Cube Ottoman	Page 82	3433-D2 Carraway Dining Arm Chair	Page 77
3333-C3 Claudia Swivel Chair	Page 60	3434-S1 Roan Sofa	Page 24
3341-C3 Enzo Swivel Chair	Page 60	3435-01 Niagara Small Ottoman.....	Page 83
3358 Samuel Series Sectional	Page 121	3435-03 Niagara Queen Ottoman.....	Page 83
3358-S1 Samuel Sofa	Page 17	3435-04 Niagara King Ottoman.....	Page 83
3363-C3 Lovato Swivel Chair	Page 60	3436-S2 Navie Curved Sofa.....	Page 25
3364 Arlington Series Sectional	Page 123	3438 Banks Series Sectional	Page 135
3364-S2 Arlington Sofa.....	Page 17	3438-S1 Banks Sofa	Page 25
3365-C3 Charlotte Swivel Chair	Page 60	3438-S2 Banks Long Sofa.....	Page 25
3369-C1 Christine Chair	Page 46	3439-02 Louise Caster Round Ottoman.....	Page 82
3371 Sarah Series Sectional.....	Page 124	3440-S1 Tracy Sofa	Page 27
3371-S1 Sarah Sofa.....	Page 18	3442-S1 Dalton Sofa.....	Page 27
3373-D1 Hopkins Dining Side Chair	Page 76	3446-S2 Clapton Sofa	Page 27
3373-D2 Hopkins Dining Arm Chair	Page 76	3448-C1 Moondance Chair	Page 47
3376 Angelina Series Sectional	Page 126	3448-C3 Moondance Swivel Chair	Page 63
3376-S2 Angelina Sofa.....	Page 18	3448-S2 Moondance Sofa.....	Page 28
3377-D2 Ariana Dining Arm Chair	Page 77	3450 Martin Series Sectional.....	Page 137
3382-S2 Raquel Sofa	Page 18	3450-S1 Martin Sofa.....	Page 28
3383-03 Rami Swivel Ottoman	Page 82	3452-C1 Sabrina Chair	Page 47
3384-S1 Kristin Sofa.....	Page 20	3452-C3 Sabrina Swivel Chair	Page 63
3388 Renee Series Sectional.....	Page 129	3452-S2 Sabrina Long Sofa	Page 29
3388-S1 Renee Sofa	Page 20	3454-S1 Kelly Sofa.....	Page 29
3394-S1 Sydney Sofa.....	Page 20	3455-B1 Eve Bench	Page 29
3400 Miller Series Sectional	Page 130	3455-C1 Eve Chair	Page 50
3400-S1 Miller Standard Sofa	Page 21	3456-S1 Godiva Sofa	Page 32
3400-S2 Miller Long Sofa	Page 21	3458 Arlo Series Sectional.....	Page 141
3403-C3 Suzette Swivel Chair	Page 62	3458-S1 Arlo Sofa	Page 32
3405-C1 Margo Chair	Page 46	3458-S2 Arlo Long Sofa	Page 32
3411-C1 Wanda Chair.....	Page 47	3459-C1 Breck Chair.....	Page 50
3413-C1 Sierra Chair	Page 47	3461-C3 Wright Swivel Chair.....	Page 63
3415-C3 Rae Swivel Chair	Page 62	3465-C1 Danza Chair	Page 50
3417-OC Dorsey Office Chair	Page 72	3469-02 Missy Caster Ottoman	Page 83
3418 Geneva Series Sectional	Page 131	3471-C3 Joshua Swivel Chair	Page 63
3418-S2 Geneva Long Sofa.....	Page 21	3473-C3 Exeter Swivel Chair.....	Page 66
3419-OC Layla Office Chair.....	Page 72	3479-C3 Halsey Swivel Chair.....	Page 66
3422-S1 Becca Sofa	Page 24	3483 Fleetwood Sectional	Page 142

INDEX BY NUMBER

3501-C3 Ridge Swivel Chair Page 66	4368-S3 Whitman Long Sofa..... Page 36
3503-C3 Edward Swivel Chair..... Page 66	4901 Amy Series Sectional..... Page 165
3505-C1 Hudson Chair Page 50	4901-S2 Amy Long Sofa Page 37
3505-01 Hudson Ottoman..... Page 50, 86	4903 Kendrick Series Sectional Page 167
3509-C3 Elton Memory Return Swivel Chair Page 67	4903-S1 Kendrick Sofa..... Page 37
3515-C1 Farley Chair Page 51	5108 Adeline Sectional..... Page 170
3517-C1 Hopper Chair Page 51	5133-C3 Andre Memory Return Swivel Chair Page 70
3519-C1 Hollie Chair..... Page 51	9015-C3 Maya Swivel Chair Page 70
3527-B1 Penrod Bench..... Page 40	9306-C3 Riley Swivel Chair Page 70
3529-C3 Wilder Swivel Chair..... Page 67	L160-TOS Peyton Leather Twin Storage Ottoman..... Page 80
3531-C1 Tuttle Chair Page 51	L2145 Ethan Series Leather Sectional..... Page 102
3533-C1 Margarete Chair Page 54	L3319-01 Simona Leather Ottoman Page 81
3535-C3 Cline Swivel Chair Page 67	L3410-LC Corkscrew Leather Swivel Chair Left Page 62
3536-S1 Newman Short Sofa Page 33	L3410-RC Corkscrew Leather Swivel Chair Right..... Page 62
3537-C1 Emerie Chair..... Page 54	L3427-03 Eastwood Leather Swivel Ottoman..... Page 82
3539-C3 Carter Swivel Chair..... Page 67	L3435-01 Niagara Leather Small Ottoman Page 83
3565 Newman Series Sectional..... Page 145	L3481-02 Melissa Leather Ottoman..... Page 83
3566 Clifton Series Sectional Page 147	Studio P A La Carte Custom Program Page 181
3567 Larabee series Sectional Page 149	Studio P Classic Suite Retreat Custom Program Page 191
3567-S2 Larabee Standard Sofa..... Page 33	Studio P Counter Proposal Custom Program..... Page 189
3568 Clavin Series Sectional Page 153	Studio P Luxe Life Custom Program Page 175
3568-S3 Clavin Long Sofa..... Page 33	Studio P Luxury Suite Retreat Custom Program..... Page 197
4110-B1 Emma 2 Seat Short Sofa Page 34	Studio P Modern Intuition Custom Program Page 203
4110-S1 Emma 3 Seat Standard Sofa Page 34	Studio P Nocturne Custom Program..... Page 173
4113-C1 Jasper Chair Page 54	Studio P Signature Sides Custom Program Page 209
4113-C3 Jasper Swivel Chair Page 70	Studio P Urban Planning Custom Program Page 183
4113-01 Jasper Ottoman Page 70	
4125 Keaton Series Sectional..... Page 155	
4125-S1 Keaton Mid Length Sofa..... Page 35	
4164-01 Dayton Ottoman..... Page 86	
4168-B1 Marley Settee Page 35	
4168-C1 Marley Chair Page 54	
4179-C1 Grayson Chair..... Page 55	
4186-C1 Hunter Chair..... Page 55	
4365 Astor Series Sectional..... Page 157	
4365-S1 Astor Short Sofa..... Page 36	
4366 Valerie Series Sectional..... Page 159	
4367 Melissa Series Sectional Page 161	
4367-S2 Melissa Standard Sofa..... Page 36	
4368 Whitman Series Sectional Page 163	

VISUAL INDEX

SOFAS



**2145-S2
Ethan 3 Cushion Sofa**
85½W 35D 34H
Page 9



**2665-S3
Jake Long Sofa**
100W 40D 34H
Page 9



**2667-S1
Connor Short Sofa**
82W 40D 34H
Page 9



**2668-S2
Marshall Standard Sofa**
91W 40D 34H
Page 10



**3015-S1
Oliver Sofa**
86W 38D 36H
Page 11



**3016-S2
Jennifer Long Sofa**
101W 42D 38H
Page 12



**3149-S1
Braden Sofa**
83W 39D 34H
Page 12



**3155-S1
Blake Sofa**
84½W 37D 33H
Page 12



**3182-S1
Bailey Sofa**
83W 35D 33½H
Page 13



**3240-S1
Lindsay Sofa**
87½W 37½D 35H
Page 13



**3242-S1
Kenzie Sofa**
87½W 37½D 35H
Page 13



**3252-S1
Corbin Standard Sofa**
88W 35D 30½H
Page 14



**3276-S1
Michelle Sofa**
83W 36½D 36H
Page 15



**3280-S1
Nicole Standard Sofa**
87W 38D 33H
Page 15



**3282-S2
Hilton Long Sofa**
100W 42D 35H
Page 15



**3286-S1
Michael Sofa**
83W 36½D 36H
Page 16



**3310-B1
Vera Short Sofa**
74½W 35½D 31H
Page 16



**3310-S1
Vera Standard Sofa**
92W 36½D 33½H
Page 16



**3320-S1
Zelda Sofa**
90½W 35½D 30H
Page 17



**3358-S1
Samuel Sofa**
91W 41D 39H
Page 17

VISUAL INDEX



3364-S2
Arlington Sofa
97W 39½D 39H
Page 17



3371-S1
Sarah Sofa
86W 36D 32½H
Page 18



3376-S2
Angelina Sofa
94½W 37D 35H
Page 18



3382-S2
Raquel Sofa
99W 36½D 34½H
Page 18



3384-S1
Kristin Sofa
89W 38½D 34½H
Page 20



3458-S1
Arlo Sofa
84W 38D 32H
Page 32



3458-S2
Arlo Long Sofa
89W 38D 32H
Page 32



3536-S1
Newman Short Sofa
82W 40D 34H
Page 33



3567-S2
Larabee Standard Sofa
91W 40D 34H
Page 33



3568-S3
Clavin Long Sofa
100W 40D 34H
Page 33



3388-S1
Renee Sofa
88W 36D 32½H
Page 20



3394-S1
Sydney Sofa
88½W 38D 31H
Page 20



3400-S1
Miller Standard Sofa
86W 38D 32H
Page 21



3400-S2
Miller Long Sofa
96W 38D 32H
Page 21



3418-S2
Geneva Long Sofa
100W 46D 29½H
Page 21



4110-B1
Emma 2 Seat Short Sofa
71W 36D 32H
Page 34



4110-S1
Emma 3 Seat Standard Sofa
88W 36D 32H
Page 34



4125-S1
Keaton Mid Length Sofa
79W 35D 31H
Page 35



4168-B1
Marley Settee
67W 30½D 32H
Page 35



4365-S1
Astor Short Sofa
82W 40D 34H
Page 36



3422-S1
Becca Sofa
92W 37D 35H
Page 24



3424-S2
Dover Sofa
97W 41D 32H
Page 24



3434-S1
Roan Sofa
87W 36D 33½H
Page 24



3436-S2
Navie Curved Sofa
92W 45D 32H
Page 25



3438-S1
Banks Sofa
84W 41D 36H
Page 25



4367-S2
Melissa Standard Sofa
91W 40D 34H
Page 36



4368-S3
Whitman Long Sofa
100W 40D 34H
Page 36



4901-S2
Amy Long Sofa
92½W 39D 37H
Page 37



4903-S1
Kendrick Sofa
90W 36½D 37½H
Page 37

CHAISE & BENCH



3438-S2
Banks Long Sofa
96W 41D 36H
Page 25



3440-S1
Tracy Sofa
92W 36D 32H
Page 27



3442-S1
Dalton Sofa
88W 34D 34H
Page 27



3446-S2
Clapton Sofa
97W 43D 35H
Page 27



3448-S2
Moondance Sofa
94W 38½D 31½H
Page 28



3226-B1
Erin Bench
78W 26D 28½H
Page 40



3241-CL
Sansa Left Arm Chaise
29½W 78½D 29H
Page 40



3241-CR
Sansa Right Arm Chaise
29½W 78½D 29H
Page 40



3527-B1
Penrod Bench
78W 26D 28½H
Page 40

ACCENT CHAIRS



3450-S1
Martin Sofa
88½W 38D 33H
Page 28



3452-S2
Sabrina Long Sofa
97W 43D 29H
Page 29



3454-S1
Kelly Sofa
89W 37D 36H
Page 29



3455-B1
Eve Bench
64W 31D 30H
Page 29



3456-S1
Godiva Sofa
93W 35½D 34H
Page 32



2107-C1
Rona Chair
33W 36D 32H
Page 42



2723-C1
Winston Chair
32½W 33D 34H
Page 42



2727-C1
Fisher Chair
27½W 35D 32H
Page 42



2753-D2
Ella Arm Chair
25W 27D 32½H
Page 42



3027-C1
Cary Chair
32W 36D 35½H
Page 43

VISUAL INDEX



3186-C1
Natalie Chair
30W 36D 41½H
Page 43



3200-C1
Tristen Chair
34W 38D 44½H
Page 43



3201-C1
Courtney Chair
30W 31D 29H
Page 43



3208-C1
Grant Chair
28W 38D 41H
Page 44



3209-C1
Erik Chair
30W 35D 38H
Page 44



4113-C1
Jasper Chair
38W 38D 36H
Page 54



4168-C1
Marley Chair
32W 30½D 32H
Page 54



4179-C1
Grayson Chair
31W 32D 32½H
Page 55



4186-C1
Hunter Chair
31W 31D 33½H
Page 55



3229-C1
Bella Chair
32W 38D 42H
Page 44



3233-C1
Aria Chair
31W 32D 29½H
Page 44



3275-C1
Kimberly Chair
30W 32½D 29H
Page 46



3279-C1
Kayla Chair
29W 33D 33½H
Page 46



3369-C1
Christine Chair
31W 32D 32½H
Page 46



2557-C3
Dalton Swivel Chair
32W 39D 33½H
Page 58



3119-C3
Gordon Swivel Chair
31W 36D 31H
Page 58



3168-C3
Phillip Swivel Chair
31W 35D 35H
Page 58



3169-C3
Ramsey Swivel Chair
31W 34D 33H
Page 58



3192-C3
Sherman Swivel Chair
31W 34D 31½H
Page 59



3405-C1
Margo Chair
28W 32½D 31H
Page 46



3411-C1
Wanda Chair
29W 34D 34½H
Page 47



3413-C1
Sierra Chair
33W 38D 33H
Page 47



3448-C1
Moondance Chair
46W 38½D 31½H
Page 47



3452-C1
Sabrina Chair
37W 37D 30H
Page 47



3257-C3
Tara Swivel Chair
31½W 36D 28½H
Page 59



3273-C3
Kathleen Swivel Chair
34W 38D 34H
Page 59



3313-C3
Luna Swivel Chair
33W 33D 32H
Page 59



3333-C3
Claudia Swivel Chair
31W 30D 29½H
Page 60



3341-C3
Enzo Swivel Chair
33½W 36½D 32½H
Page 60



3455-C1
Eve Chair
31W 31D 30H
Page 50



3459-C1
Breck Chair
31W 40D 35H
Page 50



3465-C1
Danza Chair
30W 34½D 30H
Page 50



3505-C1
Hudson Chair
28W 33D 34H
Page 50



3515-C1
Farley Chair
37W 34D 32H
Page 51



3363-C3
Lovato Swivel Chair
30½W 33D 31H
Page 60



3365-C3
Charlotte Swivel Chair
32½W 35D 33½H
Page 60



3403-C3
Suzette Swivel Chair
34½W 33D 33H
Page 62



L3410-LC
Corkscrew Leather Swivel Chair Left
34W 35D 30H
Page 62



3415-C3
Rae Swivel Chair
28W 33D 32½H
Page 62



3517-C1
Hopper Chair
29W 37D 40H
Page 51



3519-C1
Hollie Chair
29W 29D 32H
Page 51



3531-C1
Tuttle Chair
30W 30D 30H
Page 51



3533-C1
Margarete Chair
31W 34½D 32½H
Page 54



3537-C1
Emerie Chair
31W 32D 31H
Page 54



L3410-RC
Corkscrew Leather Swivel Chair Right
34W 35D 30H
Page 62



3448-C3
Moondance Swivel Chair
46W 38½D 31½H
Page 63



3452-C3
Sabrina Swivel Chair
37W 37D 30H
Page 63



3461-C3
Wright Swivel Chair
33½W 35½D 32H
Page 63



3471-C3
Joshua Swivel Chair
32W 35D 30H
Page 63

SWIVEL CHAIR

VISUAL INDEX



3473-C3
Exeter Swivel Chair
41½W 36½D 30½H
Page 66



3479-C3
Halsey Swivel Chair
28W 32D 31H
Page 66



3501-C3
Ridge Swivel Chair
36W 36½D 30½H
Page 66



3503-C3
Edward Swivel Chair
42W 42D 27H
Page 66



3509-C3
Elton Memory Return Swivel Chair
31W 31D 29½H
Page 67



3529-C3
Wilder Swivel Chair
31W 33½D 32H
Page 67



3535-C3
Cline Swivel Chair
34½W 34D 29½H
Page 67



3539-C3
Carter Swivel Chair
29W 35D 31½H
Page 67



4113-C3
Jasper Swivel Chair
38W 38D 36H
Page 70



5133-C3
Andre Memory Return Swivel Chair
30½W 28½D 30H
Page 70



9015-C3
Maya Swivel Chair
34W 35D 32H
Page 70



9306-C3
Riley Swivel Chair
34½W 36D 33½H
Page 70

OFFICE CHAIRS



3417-OC
Dorsey Office Chair
20½W 26D 37H
Page 72



3419-OC
Layla Office Chair
25½W 29D 34½H
Page 72



3423-OC
Elon Office Chair
27W 27½D 36½H
Page 72

DINING CHAIRS



2594-D1
Luc Dining Side Chair
23W 28½D 39½H
Page 75



2598-D1
Reid Dining Side Chair
23W 29D 40H
Page 75



2598-D2
Reid Dining Arm Chair
25W 29D 40H
Page 75



2753-D2
Ella Arm Chair
25W 27D 32½H
Page 75



2913-D1
Cora Dining Side Chair
24W 28D 39½H
Page 76



3130-D1
Nora Dining Side Chair
23W 28½D 39½H
Page 76



3373-D1
Hopkins Dining Side Chair
22W 25½D 35H
Page 76



3373-D2
Hopkins Dining Arm Chair
24½W 25½D 35H
Page 76



3377-D2
Ariana Dining Arm Chair
24W 26½D 31H
Page 77



3427-D2
Rainier Dining Arm Chair
26W 27D 31½H
Page 77



3433-D2
Carraway Dining Arm Chair
25½W 25D 36H
Page 77

OTTOMANS



160-00S
Peyton Queen Storage Ottoman
64W 21D 18½H
Page 80



L160-T0S
Peyton Leather Twin Storage Ottoman
43½W 21D 18½H
Page 80



2090-02
Elliot Caster Ottoman
17½W 17½D 18½H
Page 80



2233-K1
Mia Caster Keg Ottoman
22W 22D 16H
Page 80



2233-K2
Mia Caster Keg Ottoman
22W 22D 18½H
Page 80



2233-K3
Mia Caster Keg Ottoman
22W 22D 21½H
Page 80



2338-02
Leah Caster Round Ottoman
38W 38D 17H
Page 81



2541-01
Gavyn Ottoman
25W 25D 18½H
Page 81



3134-01
Drew Button Tufted Ottoman
53½W 23D 16½H
Page 81



L3319-01
Simona Leather Ottoman
27W 27D 19H
Page 81



3321-01
Tina Round Ottoman
18W 18D 18½H
Page 81



3321-03
Tina Round Ottoman
37W 37D 14H
Page 81



3321-04
Tina Square Ottoman
37W 37D 14H
Page 82



3321-05
Tina Small Cube Ottoman
23W 23D 17H
Page 82



3383-03
Rami Swivel Ottoman
26W 28D 17½H
Page 82

VISUAL INDEX



3425-01
Lorie Ottoman
53½W 23D 16½H
Page 82



L3427-03
Eastwood Leather Swivel Ottoman
26W 26D 17½H
Page 82



3439-02
Louise Caster Round Ottoman
38W 38D 17H
Page 82



L3435-01
Niagara Leather Small Ottoman
25W 20D 19H
Page 83



3435-01
Niagara Small Ottoman
25W 20D 19H
Page 83



3435-03
Niagara Queen Ottoman
49W 20D 19H
Page 83



3435-04
Niagara King Ottoman
61W 20D 19H
Page 83



3469-02
Missy Caster Ottoman
19W 19D 19H
Page 83



L3481-02
Melissa Leather Ottoman
19W 19D 19H
Page 83



3505-01
Hudson Ottoman
24W 20D 14H
Page 86



4164-01
Dayton Ottoman
53½W 21D 18H
Page 86

BEDS



130-QHR
Mackenzie Queen Headboard & Rails
67½W 89D 58H
Page 90



158-QHR
Caleb Queen Headboard & Rails
66W 93D 48½H
Page 90



161-QHR
Beckett Queen Headboard & Rails
66W 87D 59H
Page 92



161-QHS
Beckett Queen Headboard, Rails & Storage Drawer
66W 87D 59H
Page 92



176-QHR
Nebo Queen Headboard & Rails
76W 102D 45H
Page 93



178-KHR
Slater King Headboard & Rails
82½W 86D 65H
Page 93



178-THR
Slater Twin Headboard & Rails
45½W 82D 65H
Page 94



178-QHR
Slater Queen Headboard & Rails
66½W 86D 65H
Page 94



180-QHR
Forbes Queen Headboard & Rails
77½W 98D 44H
Page 95



259-QHR
Roxanne Queen Headboard & Rails
66W 88½D 41H
Page 95

SECTIONALS



2145
Ethan Series Sectional
Page 99



L2145
Ethan Series Leather Sectional
Page 102



2665
Jake Series Sectional
Page 103



2666
Kylie Series Sectional
Page 105



2667
Connor Series Sectional
Page 109



2668
Marshall Series Sectional
Page 111



3015
Oliver Series Sectional
Page 113



3182
Bailey Series Sectional
Page 115



3280
Nicole Series Sectional
Page 119



3282
Hilton Series Sectional
Page 120



3358
Samuel Series Sectional
Page 121



3364
Arlington Series Sectional
Page 123



3371
Sarah Series Sectional
Page 124



3376
Angelina Series Sectional
Page 126



3388
Renee Series Sectional
Page 129



3400
Miller Series Sectional
Page 130



3418
Geneva Series Sectional
Page 131



3438
Banks Series Sectional
Page 135



3450
Martin Series Sectional
Page 137



3458
Arlo Series Sectional
Page 141



3483
Fleetwood Sectional
Page 142



3565
Newman Series Sectional
Page 145



3566
Clifton Series Sectional
Page 147



3567
Larabee Series Sectional
Page 149



3568
Clavin Series Sectional
Page 153

VISUAL INDEX

VISUAL INDEX



4125
Keaton Series Sectional
Page 155



4365
Astor Series Sectional
Page 157



4366
Valerie Series Sectional
Page 159



4367
Melissa Series Sectional
Page 161



4368
Whitman Series Sectional
Page 163



4901
Amy Series Sectional
Page 165



4903
Kendrick Series Sectional
Page 167



5108
Adeline Sectional
Page 170

STUDIO P CUSTOM PROGRAMS



A La Carte
Custom Program
Page 181



Classic Suite Retreat
Custom Program
Page 191



Counter Proposal
Custom Program
Page 189



Luxe Life
Custom Program
Page 175

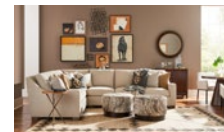

Luxury Suite Retreat
Custom Program
Page 197

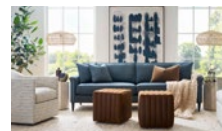

Modern Intuition
Custom Program
Page 203

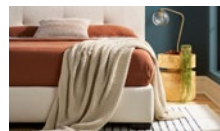

Nocturne
Custom Program
Page 173



Signature Sides
Custom Program
Page 209

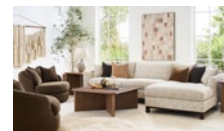

Urban Planning
Custom Program
Page 183





9S2-P2TA Modern Intuition Long Sofa
SER-003D Mado Cocktail Table

PRODUCT DESCRIPTION KEY

Style Number	○	2665-S1 Jake Short Sofa	○	Style Number
Dimensions (inches)	○	82W 40D 34H	○	Dimensions (inches)
Dimensions (inches)	○	Inside: 63W 24D	○	Dimensions (inches)
Dimensions (inches)	○	Arm Height: 24 Seat Height: 17	○	Dimensions (inches)
Product Details	○	Loose Pillow Back	○	Product Details
Product Details	○	Standard With Two 20" Throw Pillows	○	Product Details
Product Details	○	Finish Shown: Walnut	○	Product Details
Symbol Icons <small>*See Key Below</small>	○		○	Symbol Icons <small>*See Key Below</small>

SYMBOL KEY

-  Additional Styles
-  Finish Options
-  Leather Options
-  Fabric Options
-  Cushion Options
-  Nailhead Trim
-  Swivel Option
-  Swivel Glider Option



To Stay Up To Date On All Things Precedent Furniture, Follow Us On Instagram!

@SherrillFurnitureBrands

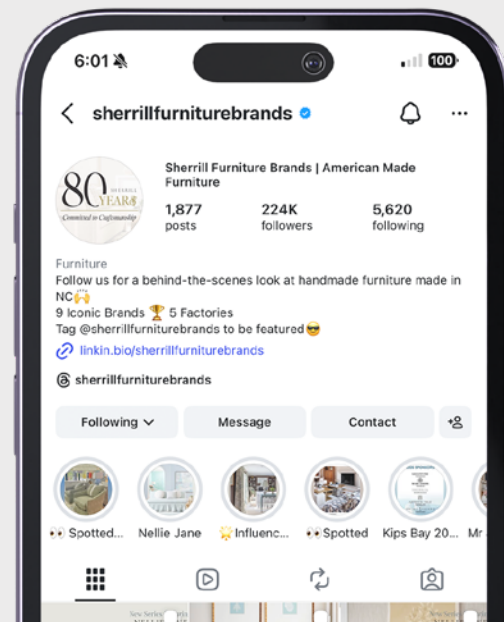

3529-C3 Wilder Swivel Chair



PRECEDENT

CATALOG 2026

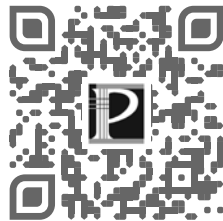

POST OFFICE BOX 189 » HICKORY, NC 28603
PHONE: (828) 465-0844 FAX: (828) 465-4630

PRECEDENT-FURNITURE.COM